

USER'S MANUAL

AXIS M10 Series

AXIS M1011 Network Camera

AXIS M1011-W Network Camera

AXIS M1031-W Network Camera

AXIS M1054 Network Camera

Notices

This manual is intended for administrators and users of the AXIS M10 Series Network Camera, and is applicable for firmware release 5.20 (AXIS M1011, AXIS M1011-W, AXIS M1031-W), firmware release 5.15 (AXIS M1054) and later. It includes instructions for using and managing the camera on your network. Previous experience of networking will be of use when using this product. Some knowledge of UNIX or Linux-based systems may also be beneficial, for developing shell scripts and applications. Later versions of this document will be posted to the Axis Website, as required. See also the product's online help, available via the Web-based interface.

AXIS M1011, AXIS M1011-W, AXIS M1031-W support ONVIF v1.0. For more information about ONVIF go to www.onvif.org For more information about enabling ONVIF go to the developers page at www.axis.com

Liability

Every care has been taken in the preparation of this manual. Please inform your local Axis office of any inaccuracies or omissions. Axis Communications AB cannot be held responsible for any technical or typographical errors and reserves the right to make changes to the product and manuals without prior notice. Axis Communications AB makes no warranty of any kind with regard to the material contained within this document, including, but not limited to, the implied warranties of merchantability and fitness for a particular purpose. Axis Communications AB shall not be liable nor responsible for incidental or consequential damages in connection with the furnishing, performance or use of this material.

Intellectual Property Rights

Axis AB has intellectual property rights relating to technology embodied in the product described in this document. In particular, and without limitation, these intellectual property rights may include one or more of the patents listed at <http://www.axis.com/patent.htm> and one or more additional patents or pending patent applications in the US and other countries.

This product contains licensed third-party software. See the menu item "About" in the product's user interface for more information.

This product contains source code copyright Apple Computer, Inc., under the terms of Apple Public Source License 2.0 (see <http://www.opensource.apple.com/apsl/>).

The source code is available from:
<http://developer.apple.com/darwin/projects/bonjour/>

Equipment Modifications

This equipment must be installed and used in strict accordance with the instructions given in the user documentation. This equipment contains no user-serviceable components. Unauthorized equipment changes or modifications will invalidate all applicable regulatory certifications and approvals.

Trademark Acknowledgments

Apple, Boa, Bonjour, Ethernet, Internet Explorer, Linux, Microsoft, Mozilla, Netscape Navigator, OS/2, Real, QuickTime, UNIX, Windows, WWW are registered trademarks of the respective holders. Java and all Java-based trademarks and logos are trademarks or registered trademarks of Sun Microsystems, Inc. in the United States and other countries. Axis Communications AB is independent of Sun Microsystems Inc.

UPnP™ is a certification mark of the UPnP™ Implementers Corporation.

Support

Should you require any technical assistance, please contact your Axis reseller. If your questions cannot be answered immediately, your reseller will forward your queries through the appropriate channels to ensure a rapid response. If you are connected to the Internet, you can:

- download user documentation and firmware updates
- find answers to resolved problems in the FAQ database. Search by product, category, or phrases
- report problems to Axis support by logging in to your private support area
- visit Axis Support at www.axis.com/techsup

Contents

Product Description	4
Key features	5
Overview	6
LED indicators	8
Accessing the Camera	9
Access from a browser	9
Setting the root password	10
Access from the Internet	10
Video Streams	14
How to stream MPEG-4/H.264	14
Motion JPEG	15
Alternative methods of accessing the video stream	15
Video & Audio Settings	16
Video Stream	16
Stream Profiles	18
Camera Settings	18
Overlay Image	19
Privacy mask	19
Audio Settings (AXIS M1031-W and AXIS M1054)	20
Audio Clips (AXIS M1031-W/AXIS M1054)	21
Layout	22
PTZ (AXIS M1054 only)	25
Preset Positions	25
Guard Tour	26
Advanced	26
Event Configuration	27
Event Servers	27
Event Types	27
Camera Tampering	29
Motion Detection	30
Port Status	31
System Options	32
Security	32
Date & Time	34
Network	34
Ports & Devices	40
LED Settings	40
Maintenance	41
Support	41
Resetting to the Factory Default Settings	42
Troubleshooting	44
Upgrading the Firmware	44
Technical Specifications	49
Set the IP address with ARP/Ping	53
Glossary of Terms	54
Index	60

Product Description

This manual applies to the AXIS M10 Series Network Camera. The information provided here applies to all models, except where otherwise indicated.

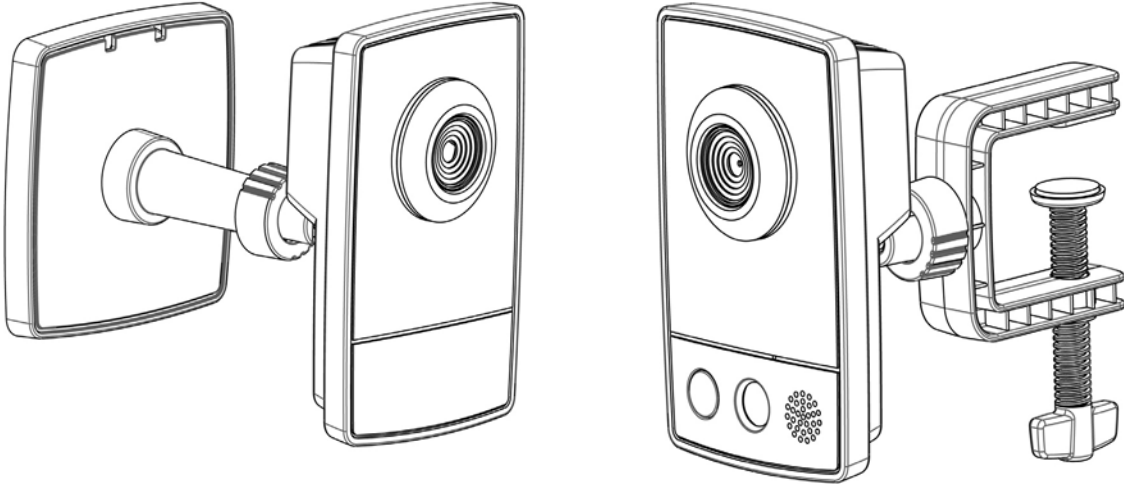

Network Camera	Features
AXIS M1011	MPEG-4 and H.264 Wired interface
AXIS M1011-W	Wired and wireless interface MPEG-4 and H.264
AXIS M1031-W	Wired and wireless interface PIR sensor Illumination LED Audio MPEG-4 and H.264
AXIS M1054	Megapixel resolution H.264 I/O PoE (Power over Ethernet) PIR sensor Illumination LED Audio Digital PTZ

Key features

- **Attractive, small-sized design**
These small, smart-looking and yet discreet cameras are perfectly suited for securing small businesses, boutiques, restaurants, hotels or residences.
- **Progressive scan**
The cameras use progressive scan technology, providing images of moving objects with no distortion.
- **Multiple H.264 streams**
Multiple H.264 and Motion JPEG streams can be provided simultaneously, individually optimized for different quality needs and bandwidth constraints. These cameras support MPEG-4 Part 2 for backward compatibility (AXIS M1054 excepted).
- **Easy and flexible installation**
AXIS M10 Series Network Cameras are easy to install, with the -W variants optionally offering wireless connectivity for added flexibility.
- **Advanced security and network management**
Axis network cameras offer advanced security and network management features such as HTTPS encryption with pre-served performance, IPv6 and Quality of Service.
- **PIR Sensor (AXIS M1031-W and AXIS M1054)**
Complementing the video motion detection capability of the cameras, the full-featured AXIS M1031-W and AXIS M1054 additionally integrate a PIR Sensor for detecting movements – even in the dark.
- **Illumination (AXIS M1031-W and AXIS M1054)**
AXIS M1031-W and AXIS M1054 offer a white LED for illuminating the scene automatically at an event or when requested by the user.
- **Microphone and speaker (AXIS M1031-W and AXIS M1054)**
AXIS M1031-W and AXIS M1054 provide two-way audio support with integrated microphone and speaker, allowing remote listening in on an area as well as communication with persons entering the scene. An event can trigger the sound of an audio clip, stored in the camera, to be emitted through the speaker.
- **Megapixel Resolution (AXIS M1054)**
The AXIS M1054 Network Camera offers superior image quality in megapixel resolution with progressive scan, providing crisp and clear images of both illuminated and dark areas.
- **PoE (Power over Ethernet) (AXIS M1054)**
The AXIS M1054 Network Camera can be powered through PoE, which simplifies installation since only one cable is needed for carrying power, as well as video controls.
- **ONVIF**
This is a global interface standard that makes it easier for end users, integrators, consultants, and manufacturers to take advantage of the possibilities offered by network video technology. ONVIF enables interoperability between different vendor products, increased flexibility, reduced cost, and future-proof systems.

Overview

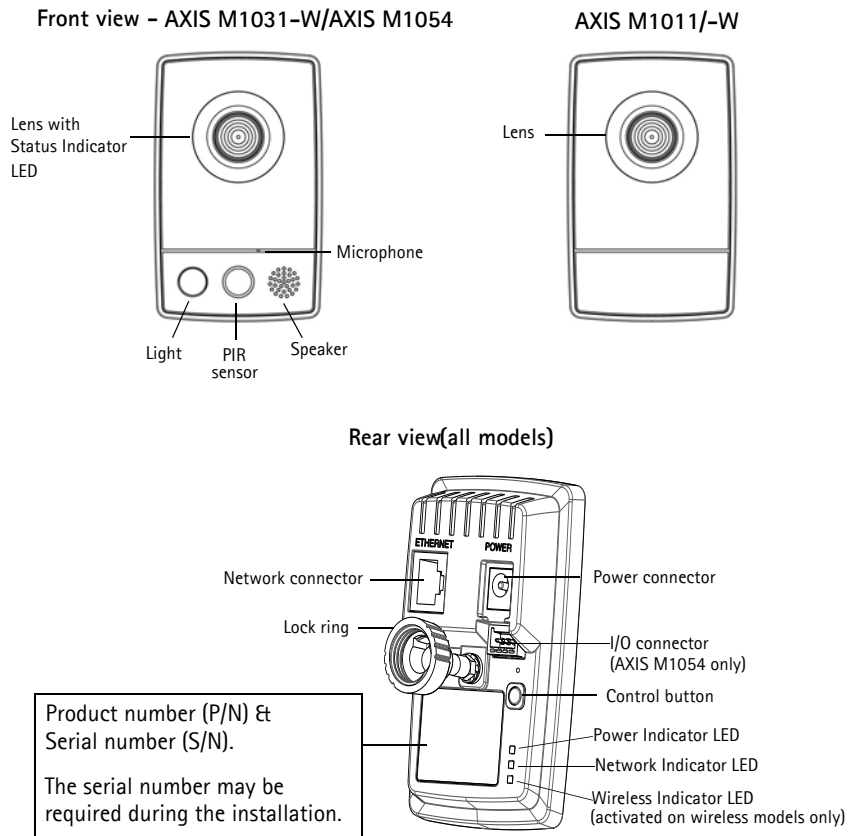

PIR Sensor – AXIS M1031-W/AXIS M1054 is equipped with a PIR Sensor that has a maximum range of 6 meters for detecting movement in the dark.

Light – White LED to illuminate the scene.

Microphone/Speaker – Two-way audio support allows for remote users to listen in on an area and communicate with visitors or intruders.

Power Connector – For connection of the PS-H or PS-V power adapter (included).

Network Connector – The camera connects to the network via a standard network connector. Supporting NWay, the camera detects the speed of the local network segment (10BaseT/100BaseTX Ethernet).

Serial Number Label – The serial number may be required during installation.

Control Button – Press this button to install the camera using the AXIS Internet Dynamic DNS Service, or to restore the factory default settings, as described in *Resetting to the Factory Default Settings*, on page 42.

Note:

AXIS Internet Dynamic DNS Service is a free service from Axis that allows you to quickly and easily install your camera. This requires an Internet connection with no HTTP proxy. See www.axiscam.net for more information.

Unit connectors

Network connector – RJ-45 Ethernet connector. Shielded cables recommended.

Power connector – Mini DC connector 5.0–5.1V DC, Max 1.5A. Center pin +.

I/O terminal connector (AXIS M1054 only)

The 4-pin I/O terminal connector provides the interface to:

- 1 transistor output
- 1 digital input
- auxiliary power
- GND

The terminal connector is used in applications for motion detection, event triggering, alarm notification via email, and image storage to FTP locations.

- Input – for connecting a push button, for example. If the push button is pressed, the state changes and the input becomes active (shown under Events > Port Status).
- Output – connects an alarm device that can be activated by Output buttons on the Live View page, or by an Event Type. The output shows as active (Events > Port Status) if the alarm device is activated.

Function	Pin	Notes
GND	1	Ground
3.3V DC Power	2	Can be used to power auxiliary equipment. Note: This pin can only be used as power out.
Digital Input	3	Connect to GND to activate, or leave floating (or unconnected) to deactivate.
Transistor Output	4	Uses an open-drain NFET transistor with the source connected to GND. If used with an external relay, a diode must be connected in parallel with the load, for protection against voltage transients.

Connect input/output devices to the camera as follows:

1. Attach the cables for the device securely to the supplied connector block.
2. Once the cables are connected, connect the connector block to the terminal connector on the camera.

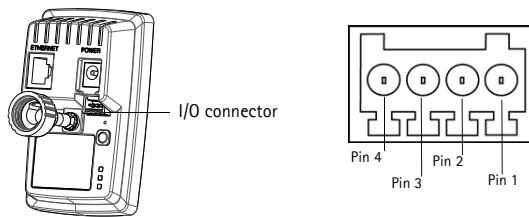

LED indicators

LED	Color	Indication
Network	Green	Steady for connection to a 100 Mbit/s network. Flashes for network activity.
	Amber	Steady for connection to 10 Mbit/s network. Flashes for network activity.
	Unlit	No network connection.
Status	Green	Steady green for normal operation. Note: The Status LED can be configured to be unlit during normal operation, or to flash only when the camera is accessed. To configure, go to Setup > System Options > LED . See the online help files for more information.
	Amber	Steady during startup, during reset to factory default or when restoring settings.
	Red	Slow flash for failed upgrade.
Power	Green	Normal operation.
	Amber	Flashes green/amber during firmware upgrade.
Wireless	Unlit	Wired mode.
	Green	Steady for connection to a wireless network. Flashes for network activity.
	Red	Steady for no wireless network connection. Flashes when scanning for wireless networks.

AXIS M1031-W and AXIS M1054 only

AXIS M1031-W and AXIS M1054 are equipped with the following:

PIR sensor - a passive infrared sensor that measures infrared light from passing objects in its field of view. If configured to do so, the camera can automatically switch on the light when triggered by the PIR sensor. Sensitivity range up to 5m (16ft).

Light - it is possible to configure so that the white illumination LED is triggered by the PIR sensor. It can also be configured via the web pages under **Setup > Live View Config > Light** buttons. Note that the light is designed for temporary use and should not be permanently lit.

Microphone/speaker for full-duplex audio.

Accessing the Camera

To install the AXIS M10 Series network cameras, refer to the installation guide supplied with your product.

The network camera can be used with most standard operating systems and browsers. The recommended browser is Microsoft Internet Explorer with Windows, Safari with Macintosh and Mozilla Firefox with other operating systems. See *Technical Specifications*, on page 49.

Notes:

- To view streaming video in Microsoft Internet Explorer, set your browser to allow ActiveX controls and install AXIS Media Control (AMC) on your computer.
- QuickTime™ is also supported for viewing H.264 and MPEG-4 streams and for audio.
- If your computer restricts the use of additional software components, the camera can be configured to use a Java applet for viewing Motion JPEG.
- The network camera includes one (1) H.264 decoder license and one (1) MPEG-4 decoder license (AXIS M1054 excepted) for viewing video streams, and (1) AAC audio license (AXIS M1031-W and AXIS M1054 only). They are automatically installed with AMC. The administrator can disable the installation of the decoders to prevent installation of unlicensed copies.

Access from a browser

1. Start a browser (Internet Explorer, Firefox).
2. Enter the IP address or host name of the camera in the **Location/Address** field of your browser.
To access the camera from a Macintosh computer (Mac OS X), click on the Bonjour tab and select one of the AXIS M10 Series from the drop-down list.
3. If this is the first time you are accessing the camera, see *Access from the Internet*, on page 10. Otherwise enter your user name and password, set by the administrator.
4. The camera's Live View page appears in your browser.

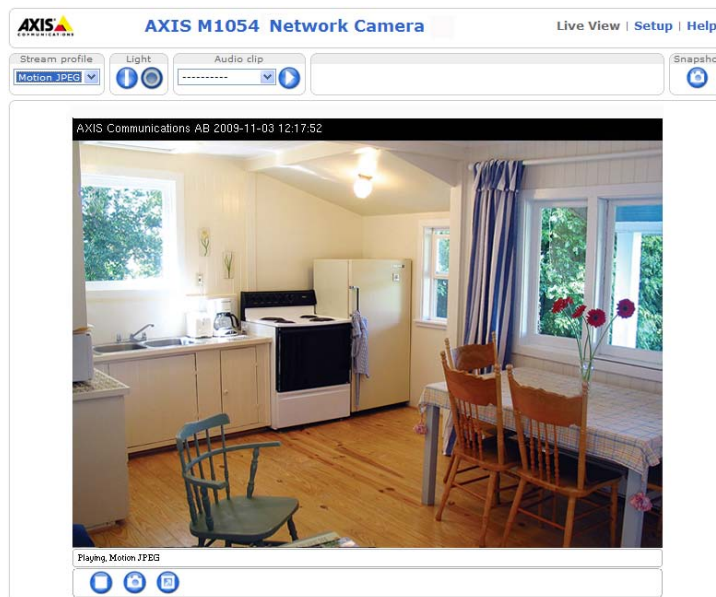

Note:

The layout of the Live View page may have been customized to specific requirements. Some of the examples and functions featured here may differ from those displayed on your own Live View page.

Setting the root password

1. When accessing the camera for the first time, the 'Configure Root Password' dialog appears.
2. Enter a password and re-enter to confirm. Click OK. The **Enter Network Password** dialog appears.
3. Enter the User name: root
4. Enter the password set in step 2, and click OK. If the password is lost, the camera must be reset to the factory default settings. See page 42.

Notes:

- The default administrator user name 'root' is permanent and cannot be deleted.
- While setting the root password, click Yes to install the AXIS Media Control (AMC), if you are prompted to. If required, click the link to install missing decoders. You will need administrator rights on the computer to do this.

The screenshot shows a web-based configuration interface for an AXIS M10 Series camera. At the top, the AXIS logo is visible. Below it, the section is titled "Create Certificate". A message states: "Secure configuration of the root password via HTTPS requires a self-signed certificate." Below this message is a button labeled "Create self-signed certificate...".

The next section is titled "Configure Root Password". It contains three input fields: "User name:" with the value "root", "Password:" (empty), and "Confirm password:" (empty). An "OK" button is located to the right of the "Confirm password" field.

Below the form, there are two informational paragraphs:

1. "The password for the pre-configured administrator root must be changed before the product can be used."

2. "If the password for root is lost, the product must be reset to the factory default settings, by pressing the button located in the product's casing. Please see the user documentation for more information."

Access from the Internet

Once connected, the camera is accessible on your local network (LAN). To access the camera from the Internet you must configure your broadband router to allow incoming data traffic to the camera. To do this, enable the NAT-traversal feature, which will attempt to automatically configure the router to allow access to the camera. This is enabled from **Setup > System Options > Network > TCP/IP Advanced**.

For more information, please see "NAT traversal (port mapping) for IPv4" (page -36). See also the AXIS Internet Dynamic DNS Service at www.axiscam.net For Technical notes on this and other topics, visit the Axis Support web at www.axis.com/techsup

Setting the root password over a secure connection

To gain access to the product, you must set the password for the default administrator user – 'root'. This is done in the 'Configure Root Password' dialog, which appears when the network camera is accessed for the first time.

To prevent network eavesdropping, the root password can be set via an encrypted HTTPS connection, which requires an HTTPS certificate (see notes below).

To set the password via a standard HTTP connection, enter it directly in the first dialog shown below.

To set the password via an encrypted HTTPS connection, follow these steps:

1. Click the **Create self-signed certificate** button.
2. Provide the requested information and click **OK**. The certificate is created and the password can now be set securely. All traffic to and from the network camera is encrypted from this point on.
3. Enter a password and then re-enter it to confirm the spelling. Click **OK**. The password has now been configured.

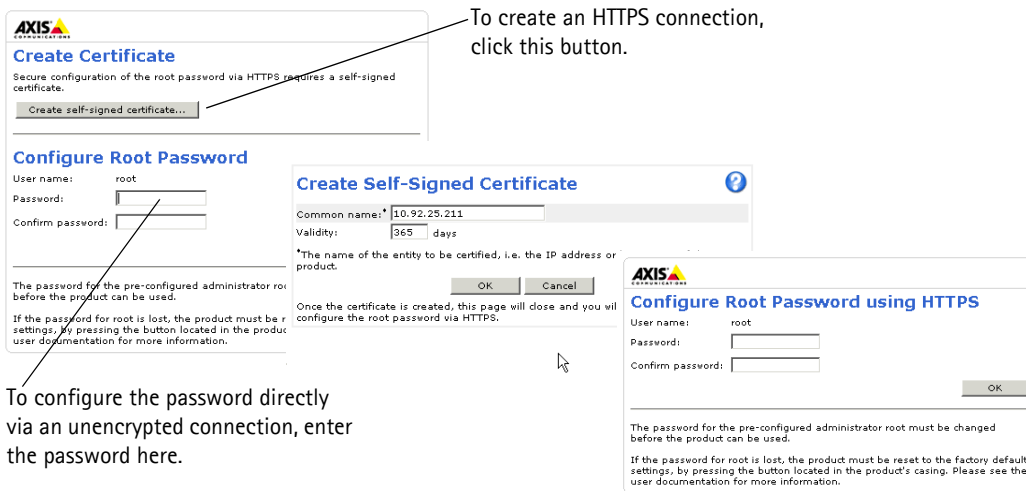

Notes:

- HTTPS (Hypertext Transfer Protocol over SSL) is a protocol used to encrypt the traffic between web browsers and servers. The HTTPS certificate controls the encrypted exchange of information.
- The default administrator user **root** cannot be deleted.
- If the password for root is lost or forgotten, the network camera must be reset to the factory default settings. See page 42.
- A warning may pop up in the browser due to the fact that the certificate is self-signed and not signed by a Trusted Certificate Authority (CA).

The Live View page

How you customize the Live View page determines which buttons are visible. Not all the buttons described below will show up unless configured to do so.

General controls

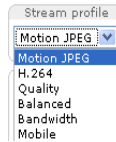

The Stream Profile drop-down list allows you to select a customized or pre-programmed stream profile on the Live View page. Stream profiles are configured under Video & Audio > Stream Profiles, see *Stream Profiles*, on page 18 for more information.



Light (Active/Inactive) – The built-in light can be controlled directly from the Live View page. The three options are Pulse, Active/Inactive and a Slider. Select **Active/Inactive** to display a button for each action: **Activate** and **Inactivate**. The light button is configured under Live View Config > Layout. For more information see *Layout*, on page 22.



Light (Pulse) – Select Pulse to display one button that activates the port with the defined Activate and Inactivate actions for the defined period.



Light (Slider) – Use this slider to adjust the brightness of the camera's white LED.

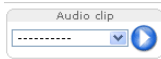

Audio clip – Audio clips can be played when an event occurs or manually from the Live View page.



The **Snapshot** button saves a snapshot of the video image on display. Right-click on the video image to save it in JPEG format on your computer. This button is primarily intended for use when the AMC viewer toolbar is not available.

AXIS Media Control (AMC) toolbar

AMC general controls

The AMC viewer toolbar (AXIS Media Control) is available in Microsoft Internet Explorer only. See *AXIS Media Control (AMC)*, on page 15 for more information. AMC displays the following buttons:



The **Play** button connects to the Axis product and starts playing a media stream.



The **Stop** button stops the video stream being played.



The **Snapshot** button takes a snapshot of the current image. The location where the image is saved can be specified using the AXIS Media Control (AMC).



Click the **View Full Screen** button and the video image will fill the entire screen. Press **Esc** (Escape) on the computer keyboard to cancel full screen view.



The **Record** button is used to record the current video stream. The location where the recording is saved can be specified using the AXIS Media Control (AMC) toolbar.

AMC audio controls (AXIS M1031-W/AXIS M1054)

AMC audio controls monitor the client computer's speaker output. These controls are only available when audio is enabled.



Click the **Speaker** Button to switch the sound off and on to your computer's speaker.



If you have set your network camera to half-duplex mode and the half-duplex **Listen** button appears first in the Live View page of your Axis network camera, you are only able to receive audio from an external camera microphone. To be able to send audio, click this button. See note below.



If you have set your network camera to half-duplex mode and the half-duplex **Talk** button appears in the Live View page of your Axis network camera if you push to talk, and you are only able to send audio to your Axis network camera. To be able to receive audio, click this button.



Click the Microphone button to switch the sound off and on to your computer's microphone.
In **Simplex – Network Camera speaker only** mode, you can click this button to stop sending audio to the network camera. See note below.



Use this slider to control the volume of the speakers and the microphone.

Note:

In **Simplex – speaker only** or **microphone only** mode, you can use either the Microphone button or the half-duplex Talk button to stop sending audio to the network camera. To send audio, both buttons must be enabled.

Video Streams

The network camera provides several image and video stream formats. Your requirements and the properties of your network will determine the type you use.

The Live View page in the network camera provides access to H.264, Motion JPEG, and MPEG-4 video streams, and to the list of available stream profiles. Other applications and clients can also access these video streams/images directly, without going via the Live View page.

Note:

AXIS M1054 does not support MPEG-4.

How to stream MPEG-4/H.264

This video compression standard makes good use of bandwidth, and can provide high quality video streams at less than 1 Mbit/s.

Your viewing requirements and the properties of your network will determine which combination of protocols and methods to use. The available options in AMC are:

Unicast RTP	This unicast method (RTP over UDP) should be your first consideration for live unicast video, especially when it is important to always have an up-to-date video stream, even if some images are dropped.	Unicasting is used for video-on-demand broadcasting, so that there is no video traffic on the network until a client connects and requests the stream. Note that there is a maximum of 20 simultaneous unicast connections.
RTP over RTSP	This unicast method (RTP tunneled over RTSP) is useful as it is relatively simple to configure firewalls to allow RTSP traffic.	
RTP over RTSP over HTTP	This unicast method can be used to traverse firewalls. Firewalls are commonly configured to allow the HTTP protocol, thus allowing RTP to be tunneled.	
Multicast RTP	This method (RTP over UDP) should be used for live multicast video. The video stream is always up-to-date, even if some images are dropped. Multicasting provides the most efficient usage of bandwidth when there are large numbers of clients viewing simultaneously. A multicast broadcast cannot however, pass a network router unless the router is configured to allow this. It is not possible to multicast over the Internet, for example. Note also that all multicast viewers count as one unicast viewer in the maximum total of 20 simultaneous connections.	

AMC negotiates with the camera to determine the transport protocol to use in the order listed above. This order can be changed and the options disabled, to suit specific requirements.

Important!

H.264, MPEG-4, and AAC are licensed technologies. The network camera includes one H.264 viewing client license; and one MPEG-4 (AXIS M1054 excepted) viewing client license, and one audio client license (AXIS M1031-W and AXIS M1054 only). Installing additional unlicensed copies of the clients is prohibited. To purchase additional licenses, contact your Axis reseller.

AXIS Media Control (AMC)

AXIS Media Control (AMC) in Microsoft Internet Explorer in Windows is the recommended method of accessing live video from the network camera.

The AMC control panel can be used to configure various video and audio settings. Please see the readme file included in the tool for more information.

The AMC control panel is automatically installed on first use, after which it can be configured. Open the AMC Control Panel from:

- Windows Control Panel (from the Start menu)
- Alternatively, right-click the video image in Internet Explorer and click **Settings** to access the AMC window.

Note:

AXIS M1011 and AXIS M1011-W do not support audio.
 AXIS M1054 does not support MPEG-4.

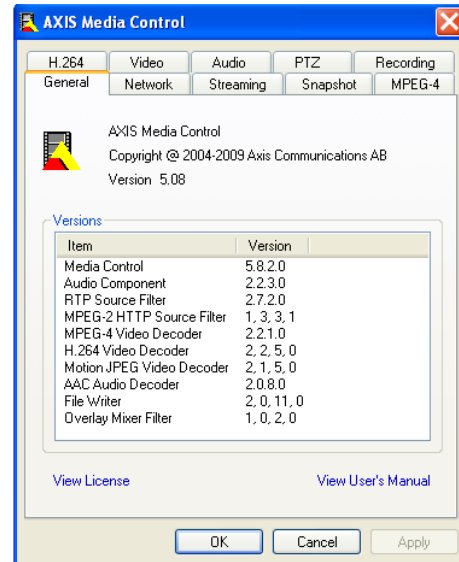

Motion JPEG

This format uses standard JPEG still images for the video stream. These images are then displayed and updated at a rate sufficient to create a stream that shows constantly updated motion.

The Motion JPEG stream uses considerable amounts of bandwidth, but provides excellent image quality and access to every image contained in the stream. The recommended method of accessing Motion JPEG live video from the network camera is to use the AXIS Media Control (AMC) in Microsoft Internet Explorer in Windows.

Alternative methods of accessing the video stream

You can also access video/images from the network camera in the following ways:

- Motion JPEG server push (if supported by the client, Firefox, for example). This option maintains an open HTTP connection to the browser and sends data as and when required, for as long as required.
- Still JPEG images in a browser. Enter the path - `http://<ip>/axis-cgi/jpg/image.cgi`
- Windows Media Player. This requires AMC and the MPEG-4/H.264 viewing client to be installed. The paths that can be used are listed below in the order of preference:
 - Unicast via RTP: `axrtpu://<ip>/axis-media/media.amp`
 - Unicast via RTSP: `axrtsp://<ip>/axis-media/media.amp`
 - Unicast via RTSP, tunneled via HTTP: `axrtsphhttp://<ip>/axis-media/media.amp`
 - Multicast: `axrtpm://<ip>/axis-media/media.amp`
- To access the video stream from QuickTime™ the following paths can be used:
 - `rtsp://<ip>/axis-media/media.amp`
 - `rtsp://<ip>/axis-media/media.3gp`

Notes:

- The network camera supports QuickTime 6.5.1 and later.
- QuickTime adds latency to the video and audio stream (up to 3 seconds).
- It may be possible to use other players to view the MPEG-4/H.264 stream using the paths above, although Axis does not guarantee this.
- <ip> = IP address

Video & Audio Settings

This section describes how to configure the camera, and is intended for product Administrators, who have unrestricted access to all settings; and Operators, who have access to the settings for Basic Setup, Video & Audio and Events.

You can configure the camera by clicking **Setup** in the top right-hand corner of the Live View page. Click  on this page to access the online help that explains the configuration menus.

Video Stream

The video stream settings appear under four different tabs:

- Image
- Audio (AXIS M1031-W and AXIS M1054)
- MPEG-4 & H.264
- MJPEG

Note:

AXIS M1054 does not support MPEG-4.

Image

Image Appearance

Use these settings to modify the image resolution and compression. Setting the compression level affects the image quality and the amount of bandwidth required; the lower the compression, the higher the image quality with higher bandwidth requirements.

Mirroring (AXIS M1054 and AXIS M1031-W only) – Mirroring is the horizontal flipping of an image, that gives you another image perspective. This is a useful function when you need a direct view of the image, for example, in ATMs and door phones. Define mirroring settings before defining parameters for privacy masks and motion detection.

Rotate image – The image can be rotated by selecting one of the available values.

See the online help  for more information.

Video Stream

To avoid bandwidth problems on the network, the **frame rate** allowed to each viewer can be limited. Select the **Unlimited** radio button option to allow the highest available frame rate; or select the **Limited to** radio button option and enter a value (1-30) fps in the field.

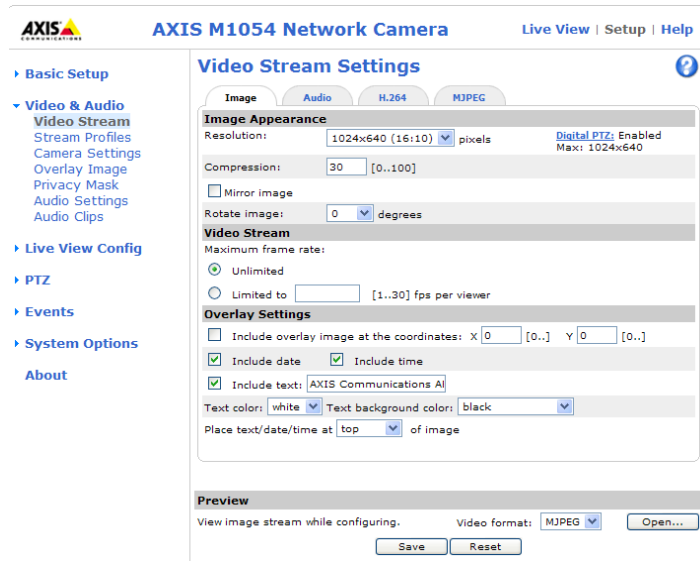

Overlay Settings

Use these settings to include text, date, and time as overlay. Click  for information on available options.

Preview

For a preview of the image before saving the adjusted settings, select the **Video Format** and click **Open...** When satisfied with the settings, click **Save**.

Audio (AXIS M1031-W and AXIS M1054)

Check the **Enable Audio** option to enable audio.

Configuration settings from **Video & Audio > Audio Settings** are displayed

under **Current Audio Settings**. See *Audio Settings (AXIS M1031-W and AXIS M1054)*, on page 20 for more information on the audio settings.

Text, date & time overlay

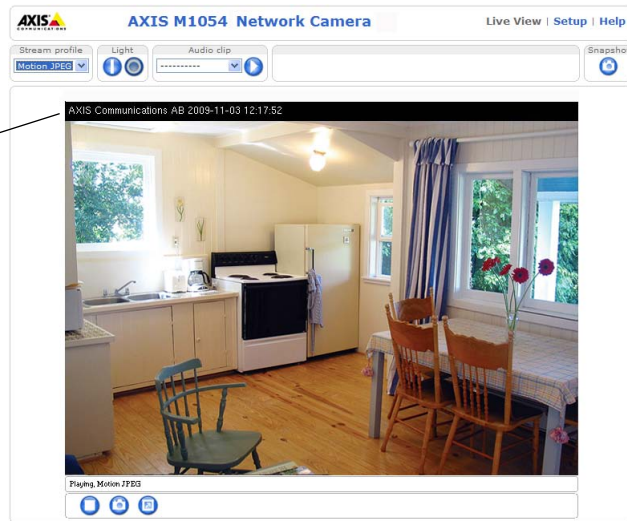

H.264 & MPEG-4

GOV Settings

The GOV structure describes the composition of the video stream. Setting the GOV-length to a higher value saves considerably on bandwidth but may have an adverse effect on image quality.

Bit Rate Control

The bit rate can be set as **Variable Bit Rate (VBR)** or **Constant Bit Rate (CBR)**.

VBR adjusts the bit rate according to the image complexity, using more bandwidth for increased activity in the image, and less for lower activity.

CBR allows you to set a fixed **Target bit rate** that consumes a predictable amount of bandwidth. As the bit rate would usually need to increase for increased image activity, but in this case cannot, the frame rate and image quality are affected negatively. To partly compensate for this, it is possible to prioritize either the frame rate or the image quality whenever the bit rate needs to be increased. Not setting a priority means the frame rate and image quality are equally affected.

Notes:

- AXIS M1054 does not support MPEG-4.
- To determine a reasonable bit rate, go to **Setup > Video & Audio > Video Stream > Image**, check the **Include** checkbox and enter the code **#b** in the **Include text:** field. The current bit rate will display as a text overlay on the **Live View** page.
- To view the image stream while configuring the GOV settings and Bit rate control, select **Open...** under **Preview**.

Preview

To view the image while configuring the settings and check how many pixels are used in an area of the image, choose a **Video format** and click **Open**.

Pixel Counter – The pixel counter is useful in situations where there is a requirement that the image is a certain size, for example face recognition.

To set the size of the rectangle enter the number of pixels in the **Width** and **Height** fields and click **Apply**. Check **Show pixel counter** to enable the box in the image.

MJPEG

Sometimes the image size is large due to low light or complex scenery. Adjusting the maximum frame size helps to control the bandwidth and storage used by the Motion JPEG video stream in these situations. Defining the frame size as **Default** provides consistently good image quality at the expense of increased bandwidth and storage usage during low light. Limiting the frame size optimizes bandwidth and storage usage, but may give poor image quality. To prevent increased bandwidth and storage usage, the maximum frame size can be limited.

Stream Profiles

There are four pre-programmed stream profiles available for quick set-up. These settings can be adjusted and new customized profiles can be created. Each profile has a descriptive name, describing its usage and/or purpose. The profiles can be accessed from the **Live View** page.

The Stream Profile List shows all the stream profiles currently configured along with a description and the type of video encoding.

- To add a new stream profile, click **Add** to bring up the **Stream Profile Settings** dialog.
- Choose a descriptive name and enter a description for your profile.
- Choose the form of **Video encoding** you wish to use from the drop-down list:
 - H.264** – Also known as MPEG-4 Part 10. This is the new generation compression standard for digital video. This function offers higher video resolution than Motion JPEG or MPEG-4 at the same bit rate and bandwidth, or the same quality video at a lower bit rate.
 - MPEG-4 part 2** – A video compression standard for digital video.
 - Motion JPEG** – Delivers a high quality video stream, from which individual images can be extracted and saved.
- **Copy** an existing stream profile to your system and rename the copy.
- **Modify** an existing stream profile based on the light situation and motion to be captured by your camera. See Stream Profile Settings for more information.
- Highlight the stream profile you wish to remove, then click **Remove** to remove it from the list.

Note:

AXIS M1054 does not support MPEG-4.

Camera Settings

This page provides access to the advanced image settings for the AXIS M10 Series.

Image Appearance

Color level – Select an appropriate level by entering a value in the range 0-100. Lower values mean less color saturation, whilst the value 100 gives maximum color saturation.

Brightness – The image brightness can be adjusted in the range 0-100, where a higher value produces a brighter image.

Sharpness – Controls the amount of sharpening applied to the image. A sharper image might increase image noise especially in low light conditions. A lower setting reduces image noise, but the image would be less sharp.

Contrast – Adjust the image's contrast by raising or lowering the value in this field.

White balance

This is used to compensate for the different colors present in different light sources, to make the colors in the image appear the same. The AXIS M10 Series can be set to automatically identify the light source and compensate for its color. Alternatively, the type of light source can be manually selected from the drop-down list. Please see the online help files [?](#) for a description of each available setting.

Exposure Settings

Configure the exposure settings to suit the image quality requirements in relation to lighting, frame rate and bandwidth considerations.

Exposure value – Adjust the slider in the bar to fine-tune the exposure.

Exposure control – This setting is used to remove 50/60 Hz flicker.

Enable Backlight compensation – When there is a bright spot of light in the image use this option to exclude that spot from the exposure calculation.

Exposure zones – This setting determines which part of the image is used to calculate the exposure. The **Auto** setting can be used in most situations, but for particular requirements, select **Defined** and click the **Edit** button to open the **Exposure Windows** dialog to custom define the exposure zone.

Exposure priority – This defines the balance between image quality and the frame rate. When Motion is prioritized, motion blur is minimized, but the image quality may be reduced with a higher frame rate. A prioritized **Low noise** will provide better image quality with a lower frame rate.

Click [?](#) for more information.

View Image Settings

Click **Save** to save the changes and click **View** to view the video stream with the current configuration.

Overlay Image

An overlay image is a static image superimposed over the video image. An overlay can be used to provide extra information, or to mask a part of the video image.

To use an overlay image in the AXIS M10 Series Network Camera, it must be selected from the drop-down list of available images. The overlay (a logo, for example) is then displayed in the video image.

To use your own image, first upload it to the network camera. To upload enter the name of the file in the field provided, or click the **Browse** button, locate and click the **Upload** button.

Privacy mask

Privacy masks are up to three configurable areas of solid color that allow concealment of parts of the image that are not to be viewable. Privacy masks cannot be bypassed via the VAPIX® Application Programming Interface (API).

The **Privacy Mask List** shows all the masks that are currently configured in the AXIS M10 Series and indicates if they are enabled.

To define a new mask:

1. Click **Add**. A rectangle appears on the image.
1. Place the rectangle over the desired area to conceal.
2. To resize, click and pull the bottom right-hand corner.
3. Choose a color, black, white, gray or red for the box from the **Privacy mask color** drop-down list.

4. Enter a descriptive name in the **Mask name** field.
5. Click **Save**.

To edit a privacy mask, select it and reshape, move or change color as needed.

For more information refer to the online Help [?](#).

Audio Settings (AXIS M1031-W and AXIS M1054)

This section describes how to configure the basic audio settings for the AXIS M1031-W/AXIS M1054 network camera.

The audio functionality is enabled under **Video & Audio > Video Stream > Audio**.

Audio Channels

Audio mode - Full duplex provides simultaneous two-way audio. Transmit and receive audio (talk and listen) at the same time.

Note:

The AXIS M1031-W/AXIS M1054 does not support echo cancelling; using the full duplex mode may cause audio feedback.

The **Half-duplex** mode transmits and receives audio in both directions, but only in one direction at a time. To speak, press and hold the button (check that the microphone is not muted). To receive audio, release the button.

Note:

The push-to-talk button is configured from AMC (see *AXIS Media Control (AMC)*, on page 15). It is possible to configure the push-to-talk button so that it toggles between the speaking and listening modes.

With the **Simplex – Network Camera speaker only** option, the speaker connected to the camera plays audio, but no audio is transmitted from the camera to other web clients. This could be used to provide spoken instructions to a person seen in the camera. This mode requires you to use the push-to-talk button.

Simplex – Network Camera microphone only mode - transmits audio only from the network camera to web clients. It does not receive audio from other web clients. This can be used in remote monitoring, and web attractions, to provide live audio and video of a monitored situation.

When using Half-duplex, the **Send the sound from the active client to all other clients** option transmits the audio signal from the client that is talking to other clients.

Audio Input

If the sound input is too low or too high, adjust the input gain for the network camera's built-in microphone.

Select the desired audio **Encoding** format, AAC, G711, G726.

If AAC is selected, select the required **Sample rate** (number of times per second the sound is sampled). The higher the sample rate, the better the audio quality and the greater the bandwidth required.

Depending on the selected encoding, set the desired audio quality (**Bit rate**). These settings affect the available bandwidth and the required audio quality.

The network camera can be set to trigger an event if the incoming sound level rises above, falls below, or passes the set value in either direction. The **Alarm level** is set between 0-100%.

Audio Output

If the sound from the speaker is too low or too high, adjust the **output gain** for the camera's speaker.

When satisfied with the settings, click **Save**, or click **Reset** to revert to previously saved settings.

Note:

To receive synchronized video in H.264/MPEG-4 and audio, it is recommended that the time settings in the camera and client computer are synchronized with an NTP Server. This is enabled in the camera under **System Options > Date & Time**. Please refer to the help pages [?](#) for more information.

Audio Clips (AXIS M1031-W/AXIS M1054)

The AXIS M1031-W/AXIS M1054 can play audio clips. Audio clips are created either by recording sound using the camera's microphone or by uploading a sound file to the camera. Audio clips can be played when an event occurs or manually from the **Live View** page.

Add a new audio clip

New audio clips can be recorded or uploaded to the network camera. Click the **Add...** button. The **Record**, **Upload** and **Location** options appear.

To record a new clip using the camera's microphone:

1. Select the **Record** radio button.
2. Enter a descriptive name in the **Name** field.
3. Enter the number of seconds to record for.
4. If the recording should not start at once upon clicking the **Record** button, enter the number of seconds to wait before recording commences.
5. Click **Record...**

To upload a file from a local hard drive or network disk, select the **Upload** radio button option. Click the **Browse** button, Navigate to the desired file and click **Upload...**

To specify a clip location, select the **Location** radio button and enter the name and the location in the respective fields. Click **Add clip**.

Audio clips allowed for uploading are .au files with G711/CCITT u-law encoding in 8000 Hz or 16000 Hz sample rate.

For more information refer to the online help [?](#).

Live View Configuration

Layout

AXIS M1054 Network Camera Live View | Setup | Help

Live View Layout ?

Stream Profile

Stream profile: Motion JPEG

Show stream profile selection

Default Viewer

Windows Internet Explorer: AMC (ActiveX)

Other Browsers: Server push

Note: QuickTime is only used with H.264. Motion JPEG will be shown with AMC in Windows Internet Explorer and with server push in other browsers.

Viewer Settings

Show viewer toolbar

Enable H.264 decoder installation

Show crosshair in PTZ joystick mode*

Use PTZ joystick mode as default*

Enable recording button

*Not applicable to AMC (ActiveX).

Action Buttons

Show manual trigger button

Show snapshot button

Play audio clip enabled

User Defined Links

<input type="checkbox"/> Show custom link 1	Use as: <input checked="" type="radio"/> cgi link <input type="radio"/> web link
Name: Custom link 1	URL: http://
<input type="checkbox"/> Show custom link 2	Use as: <input checked="" type="radio"/> cgi link <input type="radio"/> web link
Name: Custom link 2	URL: http://
<input type="checkbox"/> Show custom link 3	Use as: <input checked="" type="radio"/> cgi link <input type="radio"/> web link
Name: Custom link 3	URL: http://
<input type="checkbox"/> Show custom link 4	Use as: <input checked="" type="radio"/> cgi link <input type="radio"/> web link
Name: Custom link 4	URL: http://

Light Buttons

Light: Active/Inactive

Activate: Fade to 100%

Inactivate: Fade to off

Output Buttons

Output 1: -----

Save Reset

Stream Profile

From the **Stream Profile** drop-down list, select the stream profile to be used for the Live View page. Listed are the standard stream profiles as well as the ones created under Video & Audio > Stream Profiles. See the online help files [?](#) on this page for more information.

Default Viewer

From the drop-down lists, select the default method for viewing video images for your browser. The camera attempts to show the video images in the selected video format and viewer. If this is not possible, the camera overrides the settings and selects the best available combination.

Browser	Viewer	Description
Windows Internet Explorer	AMC	Recommended viewer in Windows Internet Explorer (H.264/MPEG-4/Motion JPEG).
	QuickTime	H.264 and MPEG-4.
	Java applet	A slower imaging alternative to AMC. Requires one of the following installed on the client: <ul style="list-style-type: none"> JVM (J2SE) 1.4.2 or higher JRE (J2SE) 5.0 or higher
	Still image	Displays still images only. Hit the Refresh button in your browser to view a new image.
Other browsers	Server Push	Recommended viewer for other browsers (Motion JPEG).
	QuickTime	MPEG-4 and H.264.
	Java applet	A slower imaging alternative to Server Push (Motion JPEG only).
	Still image	Displays still images only. Hit the Refresh button in your browser to view a new image.

Viewer Settings

Check the **Show viewer toolbar** box to display the AXIS Media Control (AMC) or the QuickTime viewer toolbar under the video image in your browser.

The administrator can disable the installation of the H.264, MPEG-4, and AAC (AXIS M1031-W/AXIS M1054) decoders included with AMC. This is used to prevent the installation of unlicensed copies. Further decoder licenses can be purchased from your Axis dealer.

The **Show crosshair in PTZ joystick mode** shows up a cross that indicates the center of the image when viewing the video stream in PTZ joystick mode (AXIS M1054 Only).

You can set the PTZ mode to joystick. Check the **Use PTZ joystick mode as default option**. (AXIS M1054 Only).

Check the **Enable recording button** to enable recording from the Live View page.

Action Buttons

The **Show manual trigger button** can be used to manually trigger and stop an event from the Live View page.

Check the **Show snapshot button** to save a snapshot from the video stream. This button is mainly intended for use with browsers other than Internet Explorer, or when not using AXIS Media Control (AMC) to view the video stream. AMC for Internet Explorer provides its own snapshot button.

Play audio clip enabled allows the user to pick an audio clip from a drop-down list and play it from the camera. See *Audio Clips (AXIS M1031-W/AXIS M1054)*, on page 21.

User-defined Links

User-defined links can be CGI links or web links. Once configured, the link(s) appear on the Live View page.

To set up a web link, select the **Use as web link** radio button, enter a descriptive name and enter the URL in the provided field. Click **Save** and the link appears in the **Live View** page.

User defined CGI links can be used to issue VAPIX API requests.

For more information on the VAPIX Application Programming Interface (API), see the [Support/Network Video/Developer](http://www.axis.com) pages on the Axis Web site at <http://www.axis.com>

Please use the online help files  for more information.

Light Buttons (AXIS M1031-W and AXIS M1054 only)

The network camera's light can be controlled directly from the **Live View** page, by enabling the display of light buttons.

To enable, select the type of control to use for the light. This can be set as **Pulse**, where clicking the single button activates the port with the defined **Activate** and **Inactivate** actions for the defined period, or as **Active/Inactive**, which displays 2 buttons, one for each action. The selected type automatically displays the correct button(s) on the **Live View** page.

The pulse time can be set as short as 1/100 second, and as long as 60 seconds.

For advanced users it is also possible to specify a custom **Activate** and **Inactivate** command sequence, using **Plain config**.

Note:

The white LED is not for continuous use.

Output Buttons

An output on the AXIS M1054 Network Camera can be controlled directly from the **Live View** page, by enabling the display of output buttons.

To enable these buttons, select the type of control to use for the port. This can be set as **Pulse**, where clicking the single button activates the port for the defined period, or as **Active/Inactive**, which displays two buttons, one for each action. The correct button(s) are automatically displayed in the **Live View** page.

The pulse time can be set as short as 1/100 second, and as long as 60 seconds.

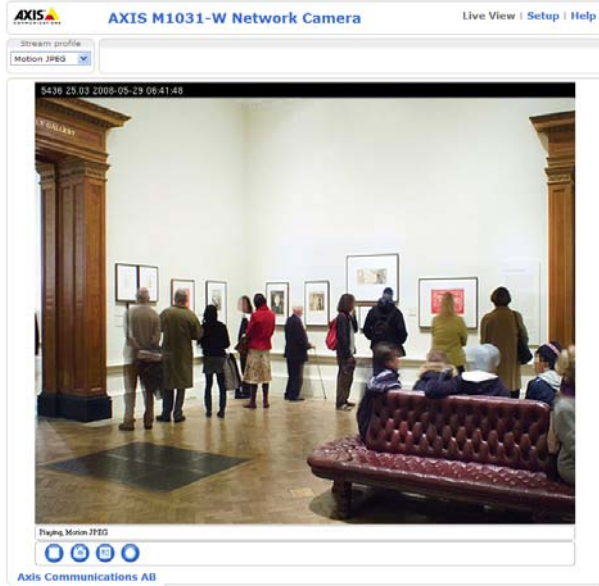

User-defined Link

PTZ (AXIS M1054 only)

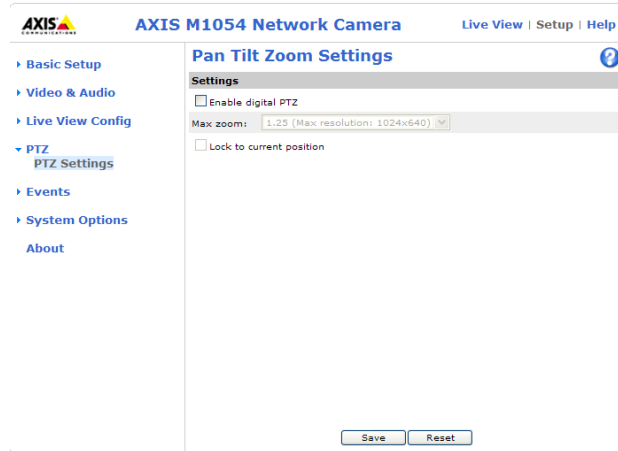

Enable digital PTZ - Check this box and click **Save** to enable digital pan/tilt/zoom and PTZ controls in Live View.

Max zoom - Set the maximum possible zoom rate in Live View. Note that by increasing the maximum zoom rate you will be decreasing the maximum possible resolution in the Live View Image. See Video & Audio > Video Stream Settings > Image.

Lock to current position - This option disables PTZ in the Live View. Click in the image or use the Pan/Tilt/Zoom controls to navigate the view to the desired area. Select the **Lock to current position** box option.

Preset Positions

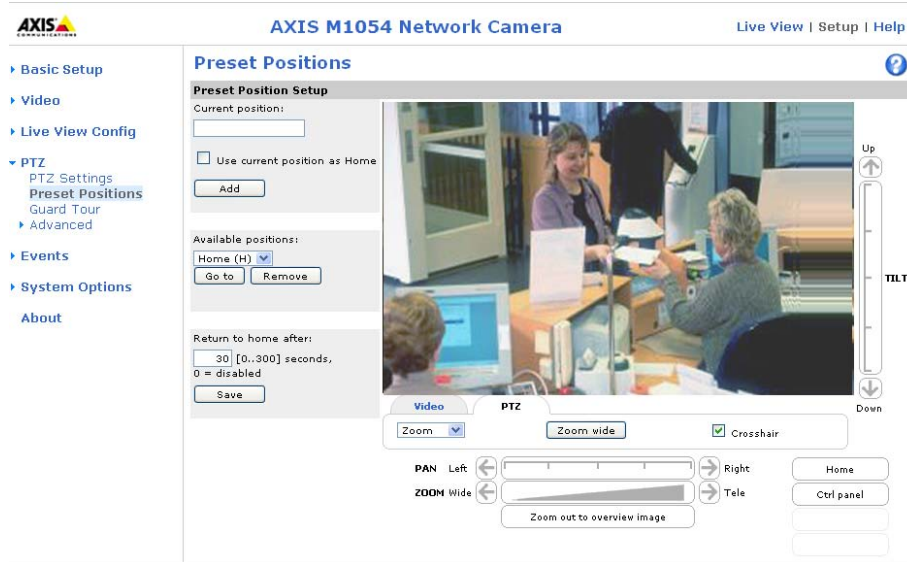

Creating a new preset position

A preset position is a pre-defined camera view that can quickly and easily be viewed, simply by selecting the preset's name. Using the Pan, Tilt and Zoom (PTZ) controls, move the camera view to the required position. When satisfied with the camera view, enter a descriptive name for the position in the **Current position** field.

Select the **Use current position as Home** box option and click **Add**. This camera position is then saved as a preset position in the camera. The position can be assumed at any time, by selecting it from the drop-down list of available positions. Presets can be selected in Live View, from events, from the Guard Tour and in Sequence mode.

Deleting a Preset Position

From the **Available positions** drop-down list, select the preset name to delete. Click **Remove**.

Use Current Position as Home

Selecting this box option will save this preset as the Home position, which is then readily accessible by clicking on the **Home** button in both the **Preset Position Setup** window and the **Live View** window. The position's name will also have (H) added to the end of it.

Return to home after

This setting is used to return the camera to the home position after a set time of viewing a preset position. The interval is configurable from 0 seconds (i.e. disabled) to 300 seconds.

Guard Tour

A Guard Tour displays the video streams from different preset positions, one-by-one, in a pre-determined order or at random, and for configurable time periods. Once the preset position has been set, and added to the guard tour, you can decide the viewing time in seconds or minutes in the Guard Tour Setup window. You can also decide the order in which you will view these presets, or you can choose a Random view order in this same window.

Advanced

The Control Settings enable managing the different controls provided for PTZ.

The **Panel Shortcut Command Buttons** are controls for creating and saving Panel Shortcut Command Buttons. The buttons are displayed in the PTZ Panel, which can be viewed in the **Live View** page by clicking the **Ctrl panel** button.

See the online help files [?](#) on this page for more information.

Event Configuration

An event or Event Type in the camera triggers certain actions when activated. An event type is a set of parameters that defines these actions. A common event type is an alarm that causes the camera to upload images. Many event types use an Event Server to receive uploaded images.

This section describes how to configure the camera to perform certain actions when events occur.

Definitions

Event type	A set of parameters describing how and when the camera performs certain actions
Triggered Event – see page 28	An event that is started by some sort of signal, for example, an external device such as a door switch, motion detection, or system event.
Scheduled Event – see page 29	Pre-programmed time period(s) during which an event will run.
Action	This occurs when the event runs, for example, uploading of images to an FTP server, or email notification.

Event Servers

Event Servers are used to receive uploaded image files and/or notification messages. To set up Event Server connections in your camera, go to **Setup > Event Configuration > Event Servers** and enter the required information for the required server type.

Server type	Purpose	Information required
FTP Server	<ul style="list-style-type: none"> Receives uploaded images 	<ul style="list-style-type: none"> Descriptive name of your choice Network address (IP address or host name) User Name and Password
HTTP Server	<ul style="list-style-type: none"> Receives notification messages Receives uploaded images 	<ul style="list-style-type: none"> Descriptive name of your choice URL (IP address or host name) User Name and Password
TCP Server	<ul style="list-style-type: none"> Receives notification messages 	<ul style="list-style-type: none"> Descriptive name of your choice Network address (IP address or host name) Port number

For details on each setting, see the online help  available from each web page.

When the setup is complete, the connection can be tested by clicking the **Test** button (the connection test takes approximately 10 seconds).

Event Types

An Event Type describes how and when the camera performs certain actions.

Example: If somebody passes in front of a camera and an event has been configured to detect and respond to motion, the camera can record and save images to an FTP server, and can send a notification e-mail to an e-mail address. Images can be sent as e-mail attachments.

Triggered Event

A triggered event could be activated by:

- The PIR Sensor is activated by movement (AXIS M1031-W and AXIS M1054)
- A manually activated action, such as from an action button in the web interface
- Detected movement in a configured motion detection window
- Sound at a certain decibel level (AXIS M1031-W and AXIS M1054)
- On restart (reboot), after power loss
- A change in temperature (AXIS M1031-W only)
- Camera tampering
- Input ports (AXIS M1054)

How to set up a triggered event

The following example describes how to set up the camera to upload images when the main door is opened.

1. Click **Add triggered...** on the **Event Types** page. The **Triggered Event Type Setup** page appears.
2. Enter a descriptive **Name** for the event, such as Main door open.
3. Set the **Priority** - High, Normal or Low (see the online help).
4. Set the **Respond to Trigger...** parameters to define when the event is active, for example, after office hours.
5. Select the trigger alternative from the **Triggered by...** drop-down list. For example, select the PIR Sensor to detect moving infrared objects in the dark.
6. Set the **When Triggered...** parameters, that is, define what the camera will do if the main door is opened - upload images to an FTP server or send an e-mail notification.
7. Click **OK** to save the event in the Event Types list.

Please see the online help  for descriptions of each available option.

Note

Up to 10 event types can be configured in the camera, and up to three of these can be configured to upload images. File names can be formatted according to specific requirements. See File Naming & Date/Time Formats online help.

Pre-trigger and Post-trigger buffers

This function is very useful when checking to see what happened immediately before and/or after a trigger, for example, 30 seconds before and/or after a door was opened. Check the **Save stream** checkbox under **Event Types > Add Triggered... > When Triggered...** to view the options. All uploaded images are JPEG images.

Include pre-trigger buffer - images stored internally in the server from the time immediately preceding the trigger. Check the box to enable the pre-trigger buffer, enter the desired length of time and specify the required image frequency.

Include post-trigger buffer - contains images from the time immediately after the trigger. Configure as for pre-trigger.

Note

- Pre-trigger and Post-trigger buffers will be lost if the connection to the event server fails
- The maximum length of the pre-/post-buffer depends on the video image size and selected frame rate
- If the pre- or post-buffer is too large for the camera's internal memory, the frame rate is reduced and no images will be uploaded. If this occurs, an entry is created in the unit's log file

Continue image upload (unbuffered) – enables the upload of video images for a fixed length of time. Specify the length of time for the uploaded recording, in seconds, minutes or hours, or for as long as the trigger is active. Finally, set the desired image frequency to the maximum (the maximum available) or to a specified frame rate. The frame rate will be the best possible, but might not be as high as specified, especially if uploading via a slow connection.

Scheduled Event

A **Scheduled event** can be activated at preset times, in a repeating pattern on selected weekdays.

Configuration example:

1. Click **Add scheduled...** on the **Event Types** page.
2. Enter a descriptive **Name** for the event, such as Scheduled e-mail upload.
3. Set the **Priority** (High, Normal or Low).
4. Set the **Activation Time** parameters (24h clock) for the event – start on Sundays at 13.00 with a duration of 12 hours.
5. Set the **When Activated...** parameters, (what the camera does at the specified time) for example, send uploaded images to an e-mail address.
6. Click **OK** to save the Event in the Event Types list.

Please see the online help  for descriptions of each available option.

Camera Tampering

The camera tampering application generates an alarm whenever the camera is repositioned, or when the lens is covered, sprayed, or severely defocused.

First, you must create an event, see *How to set up a triggered event, on page 28*, for the camera to send an alarm when tampering is detected.

Settings

The **Minimum duration** parameter sets the minimum tampering period, that is, an alarm will not be triggered until this period has elapsed, even if the tampering conditions are otherwise met. This can help prevent false alarms for known conditions that affect the image.

If the camera lens is sprayed or covered so that the camera live view becomes dark, it will not be possible to distinguish this situation from other situations where the same effect is seen, such as when lighting conditions change.

When the **Alarm for dark images** parameter is enabled, alarms are generated for all cases where the lights are either dimmed or turned off, or if the lens is sprayed, covered, or rendered severely out of focus. If not enabled, no alarm will be sent.

After you define these settings, click **Save**.



Motion Detection

The AXIS M10 Series can detect moving objects in its field of vision using video motion detection. The AXIS M1031-W and AXIS M1054 can also detect infrared object motion using the PIR Sensor (see page 31).

Video Motion Detection

Video motion detection is used to generate an alarm whenever movement occurs (or stops) in the video image. A total of 10 Include and/or Exclude windows can be configured.

- **Included** windows target specific areas within the whole video image
- **Excluded** windows define areas within an Include window that should be ignored (areas outside Include windows are automatically ignored)

Once configured, the video motion detection windows appear in the list of available triggers, for triggering events. See *How to set up a triggered event, on page 28*.

Notes:

- Using the motion detection feature may decrease the camera's overall performance
- Video motion detection may often be falsely triggered by shadows, lamps, etc. Generally, motion detection using the PIR Sensor is more reliable.



Configuring Motion Detection

1. Click **Motion Detection** in the **Event Configuration** menu.
2. Select whether you want to configure Include or Exclude windows.
3. Click **New** against **Windows Name** and enter a descriptive name in the field below.
4. Adjust the size (drag the bottom right-hand corner) and position (click on the text at the top and drag to the desired position) of the active window.
5. Adjust the **Object Size**, **History** and **Sensitivity** profile sliders (see table below for details). Any detected motion within an active window is then indicated by red peaks in the **Activity** window (the active window has a red frame).
6. Click **Save**.

To exclude parts of the Include window, select the **Exclude** option and position the **Exclude** window as required, within the **Include** window.

Please see the online help  for descriptions of each available option.

	Object Size	History	Sensitivity
High level	Only very large objects trigger motion detection	An object that appears in the region will trigger the motion detection for a long period	Ordinary colored objects on ordinary backgrounds will trigger the motion detection
Low level	Even very small objects trigger motion detection	An object that appears in the region will trigger motion detection for only a very short period	Only very bright objects on a dark background trigger motion detection
Default value	Low	High	High

Examples:

- Avoid triggering on small objects in the video image by setting the **object size** level too high.
- Use several small Motion Detection windows rather than one large window, if triggers on small movements or objects are desired.
- To reduce the number of triggers if there is a lot of movement during a short period of time, select a high **history** level.
- To only detect flashing light, select low **sensitivity**. In other cases, a high **sensitivity** level is recommended.

PIR Sensor

The AXIS M1031-W/AXIS M1054 is also able to detect motion using the PIR Sensor. Since the PIR Sensor can detect a moving infrared object such as a person in the dark, it can be used as an intruder alarm when, for example, a thief tries to break into a building at night.

A triggered event using the PIR Sensor can be configured so that when an alarm is activated, the AXIS M1031-W/AXIS M1054 can play an audio clip and flash the LED (see *How to set up a triggered event*, on page 28).

If a video clip also needs to be uploaded, an event server can be configured (see *Event Servers*, on page 27).

To adjust the sensitivity of the PIR Sensor, see *PIR Sensor*, on page 40.

Port Status

This list shows the status for the 2 input ports and 1 output port supported by the AXIS M1054 Network Camera.

The ports shown in the list cannot be configured here – this must be done from **System Options > Ports & Devices** – this requires administrator access.

System Options

Security

Users

User access control is enabled by default. An administrator can set up other users, by giving these user names and passwords. It is also possible to allow anonymous viewer login, which means that anybody may access the Live View page, as described below:

The user list displays the authorized users and user groups (levels):

Viewer	Provides the lowest level of access, which only allows access to the Live View page.
Operator	An operator can view the Live View page, create and modify events, and adjust certain other settings. Operators have no access to System Options.
Administrator	An administrator has unrestricted access to the Setup tools and can determine the registration of all other users.

The AXIS M10 Series Network Camera supports different methods of user authentication:

HTTP Basic Authentication – This authenticates the user by requesting a user name and a password. The exchange of network credentials is in simple base64 coding and is not encrypted.

HTTP Digest Authentication – This method also requests a user name and password, but the exchange of credentials is encrypted, which secures it against eavesdropping.

HTTP/RTSP Password Settings – Select the type of password to allow. You may need to allow unencrypted passwords if there are viewing clients that do not support encryption, or if you recently upgraded the firmware and the existing clients do support encryption, but need to log in again, and be configured to use this functionality.

User Settings – Check the relevant box to enable **anonymous viewer login** – allows any viewer direct access to the Live View page.

Enable Basic Setup – Before using the AXIS M10 Series Network Camera, there are certain settings that should be made, most of which require Administrator access privileges. To quickly access these settings use the Basic Setup in the menu. All settings are also available from the standard setup links in the menu. Basic Setup is enabled by default but can be disabled and removed from the menu.

IP Address Filter

Enable IP Address Filtering to allow or deny access to the network camera. Once enabled, the IP addresses in the list are allowed or denied access according to the selection made in the drop-down list **Allow/Deny the following IP addresses**.

The administrator can add up to 256 IP address entries to the list (a single entry can contain multiple IP addresses).

All other IP addresses not in this list will be allowed or denied access accordingly. In other words, if the addresses in the list are allowed, then all others are denied access, and vice versa.

HTTPS

The network cameras support encrypted browsing using HTTPS.

A **self-signed certificate** can be used until a Certificate Authority-issued certificate has been obtained. Click the **Create self-signed Certificate** button to install a self-signed certificate. Although self-signed certificates are free and offer some protection, true security is only implemented after the installation of a signed certificate issued by a certificate authority.

A signed certificate can be obtained from an issuing Certificate Authority by clicking the **Create Certificate Request** button. When the signed certificate is returned, click the **Install signed certificate** button to import the certificate. The properties of any certificates or certificate requests currently resident or installed in the camera can also be viewed by clicking the **Properties...** button. The HTTPS Connection Policy must also be set in the drop-down lists to enable HTTPS in the camera.

For more information, please refer to the online help [?](#).

IEEE 802.1X

IEEE 802.1X is a standard for port-based Network Admission Control providing secure authentication of wired and wireless network devices. IEEE 802.1X is based on EAP (Extensible Authentication Protocol).

To access a network protected by IEEE 802.1X, devices must authenticate themselves. The authentication is performed by a third-party entity called an authentication server, typically a RADIUS server, examples of which are FreeRADIUS and Microsoft Internet Authentication Service.

In Axis implementation, the network device and the authentication server authenticate themselves with the help of digital certificates using EAP-TLS (Extensible Authentication Protocol – Transport Layer Security). The certificates are provided by an Certification Authority (CA). You need:

- a CA certificate to validate the identity of the authentication server
- a CA-signed client certificate and a private key to authenticate the network device.

To allow the network device to access a network protected by IEEE 802.1X:

1. Obtain a CA certificate, a client certificate and a client private key (contact your network administrator).
2. Go to Setup > System Options > Security > IEEE 802.1X and upload the CA certificate, the client certificate and the client private key.
3. Under SETTINGS, select the EAPOL version, provide your EAP identity and private key password.
4. Check the box to enable IEEE 802.1X and click Save.

Note:

- For the authentication to work properly it is important to synchronize the time in the AXIS M1031-W Network Camera with an NTP server.
- It is recommended to use an NTP server for time synchronization. The AXIS M10 Series network camera's clock stops when there is no power. The NTP server will synchronize the time automatically when power is restored.

Certificates

Certificates	
CA Certificate	The CA certificate is used to validate the identity of the authentication server. Enter the path to the certificate directly, or locate the file using the Browse button. Then click Upload. To remove a certificate, click Remove.
Client Certificate	The client certificate and private key are used to authenticate the network device. They can be uploaded as separate files or in one combined file (e.g. a PFX file or a PEM file). Use the Client Private Key field if uploading one combined file. For each file, enter the path to the file, or locate the file using the Browse button. Then click Upload. To remove a file, click Remove.
Client private key	
Settings	
EAPOL Version	Select the EAPOL version (1 or 2) as used in your network switch.
EAP Identity	Enter the user identity (maximum 16 characters) associated with your certificate.
Private Key Password	Enter the password (maximum 16 characters) for the private key.
Enable IEEE 802.1X	Check the box to enable the IEEE 802.1X protocol.

Audio Support

Enable audio support – Allow clients to retrieve audio streams from the AXIS M1031-W/AXIS M1054. See also *Audio Settings (AXIS M1031-W and AXIS M1054)*, on page 20 for information on how to configure the audio settings.

Notes:

- This parameter will enable/disable audio globally in the camera, even for configured events and profiles with audio.
- Disabling audio support will disable audio clips.

Date & Time

Current Server Time – displays the current date and time (24h clock). The time can be displayed in 12h clock format in the overlay (see below).

New Server Time – select your time zone from the drop-down list. If you want the server clock to automatically adjust for daylight savings time, select the **Automatically adjust for daylight saving time changes**.

From the **Time Mode** section, select the preferred method to use for setting the time:

- **Synchronize with computer time** – sets the time from the clock on your computer.
- **Synchronize with NTP Server** – the camera will obtain the time from an NTP server on a regular basis. The NTP server's IP address or host name is specified under **Advanced TCP/IP Settings**. Check this option if using IEEE 802.1X.
- **Set manually** – this option allows you to manually set the time and date.

Note:

- If using a host name for the NTP server, a DNS server must be configured under TCP/IP settings. See **Network > Basic TCP/IP Settings** below.
- It is recommended to use an NTP server for time synchronization. The AXIS M10 Series network camera's clock stops when there is no power. The NTP server will synchronize the time automatically when power is restored.

Date & Time Format Used in Images – specify the formats for the date and time (12h or 24h) displayed in the video streams.

Use the predefined formats or use your own custom date and time formats. See **Advanced File Naming & Date/Time Formats** in the online help  for information on how to create your own date and time formats.

Network

Basic TCP/IP Settings

The AXIS M10 Series supports both IP version 4 and IP version 6. Both versions may be enabled simultaneously, and at least one version must always be enabled. When using IPv4, the IP address for the camera can be set automatically via DHCP, or a static IP address can be set manually. If IPv6 is enabled, the network cameras receive an IP address according to the configuration in the network router. There are also the option of using the AXIS Internet Dynamic DNS Service. For more information on setting the IP address, please see the online help.

Network Settings – Click the **View** button for an overview of the IP configuration of the network camera.

Network Interface Mode – The network interface to the AXIS M1011-W/AXIS M1031-W Network Camera can be wired or wireless. Different settings can be used for each network interface, but only one can be used at a time. Check the relevant radio button to decide how the different network interfaces will be selected.

IPv4 Address Configuration – Ethernet – These settings are grouped according to the network interface and the version of Internet Protocol (IP). The AXIS M10 Series supports both IP version 4 and IP version 6. Both versions may be enabled simultaneously, and at least one version must always be enabled.

When using IPv4, the IP address for the camera can be set automatically via DHCP, or a static (fixed) IP address can be set manually. If IPv6 is enabled, the camera will receive an IP address according to the configuration in the network router.

There are also options for setting up notification of changes in the IP address, and for using the AXIS Internet Dynamic DNS Service. For more information on setting IP addresses, please see the online help  .

Notes:

- DHCP is a protocol for automatic IP address assignment on a network. IP address assignment via DHCP may lead to the situation where the IP address changes and you lose contact with the camera. Configure the options for notification of IP address change (under Services) to receive notification from the camera when the IP address changes.
- Alternatively, if your DHCP server can update a DNS server, you can access the AXIS M10 Series by host name, which is always the same, regardless of the IP address.

IPv6 Address Configuration – Ethernet – Check the box to enable IPv6. Other settings for IPv6 are configured in the network router.

IPv4 Address Configuration – Wireless (AXIS M1011-W/AXIS M1031-W) – It is possible to have a separate configuration for IPv4 Address – wireless. The configuration is similar as for the Ethernet option.

Obtain IP address via DHCP

Dynamic Host Configuration Protocol (DHCP) is a protocol that lets network administrators centrally manage and automate the assignment of IP addresses on a network. DHCP is enabled by default. Although a DHCP server is mostly used to set an IP address dynamically, it is also possible to use it to set a static, known IP address for a particular MAC address.

Note:

DHCP should only be enabled if your DHCP server can update a DNS server, which then allows you to access the AXIS M10 Series Network Camera by name (host name). If DHCP is enabled and you cannot access the unit, run AXIS IP Utility to search the network for connected Axis products or reset the network camera to factory default settings and then perform the installation again.

Use the following IP address

To use a static IP address for the AXIS M10 Series Network Camera, check the radio button and then make the following settings:

- IP address – Specify a unique IP address for your network camera. (To check if the IP address you intend to use is available or not, click the Test button)
- Subnet mask – Specify the mask for the subnet the network camera is located on
- Default router – Specify the IP address of the default router (gateway) used for connecting devices attached to different networks and network segments.

IPv6 Address Configuration – Wireless (AXIS M1011-W/AXIS M1031-W) – It is possible to have a separate configuration for IPv6 Address – wireless. The configuration is similar to the Ethernet option.

Services – Enable ARP/Ping setting of IP address – The IP address can be set using the ARP/Ping method, which associates the unit's MAC address with an IP address. Check this box to enable the service. Leave disabled to prevent unintentional resetting of the IP address.

Notes:

- The ARP/Ping service is automatically disabled two minutes after the unit is started, or as soon as an IP address is set. In order to reset the IP address, the camera must be restarted to activate ARP/Ping for an additional two minutes.
- Pinging the unit is still possible when this service is disabled.

Enable AVHS – AXIS Video Hosting System (AVHS) in conjunction with an AVHS service provides easy and secure Internet access to live and recorded video accessible from any location. For more information and help to find a local AVHS Service Provider please go to www.axis.com. If AVHS is not to be used this option can be disabled.

- **One-click enabled** – Press the camera’s control button (see *Overview*, on page 6) to connect to an AVHS service over the Internet. Once registered the camera stays connected to the AVHS service. If the camera is not registered within 24 hours after the button is pressed, the camera will disconnect from the AVHS service.
- **Always** – The camera will constantly attempt to connect to the AVHS service over the Internet. Once registered the camera will stay connected to the service. This option can be used when the camera is already installed and it is not convenient to use the one-click installation.

AXIS Internet Dynamic DNS Service – Use the AXIS Internet Dynamic DNS service to assign a host name for easy access to your network camera (requires Internet access).

Click **Settings...** to register the camera with the Axis Internet Dynamic DNS service, or to modify the existing settings (requires access to the Internet). The domain name currently registered at the Axis Internet Dynamic DNS service for your product can at any time be removed.

For more information, please refer to the online help  .

Advanced TCP/IP Settings

DNS Configuration – DNS (Domain Name Service) provides the translation of host names to IP addresses on your network.

Obtain DNS server address via DHCP – automatically use the DNS server settings provided by the DHCP server. Click the **View** button to see the current settings.

Use the following **DNS server address** – enter the desired DNS server by specifying the following:

Domain name – enter the domain(s) to search for the host name used by the network cameras. Multiple domains can be separated by semicolons (;). The host name is always the first part of a Fully Qualified Domain Name, for example, **myserver** is the host name in the Fully Qualified Domain Name **myserver.mycompany.com** where **mycompany.com** is the Domain name.

DNS servers – enter the IP addresses of the primary, and secondary DNS servers.

NTP Configuration – **Obtain NTP server address via DHCP** – check this radio button to automatically look up and use the NTP server settings as provided by DHCP. Click the **View** button to see the current settings.

Use the following **NTP server address** – to create manual settings, check this radio button and enter the host name or IP address of the NTP server.

Host Name Configuration – The network cameras can be accessed using a host name, instead of an IP address. The host name is usually the same as the assigned DNS Name.

For more information, please see *Security*, on page 32.

Link-Local IPv4 Address – This is enabled by default and assigns the network cameras an additional IP address for use with UPnP™. The camera can have both a Link-Local IP and a static/DHCP-supplied IP address at the same time – these will not affect each other.

HTTP and HTTPS – The default HTTP/HTTPS port numbers (80 and 443 respectively) can be changed to any port within the range 1024-65535. This is useful for simple security port mapping, for example.

NAT traversal (port mapping) for IPv4 – A broadband router allows devices on a private network (LAN) to share a single connection to the Internet. This is done by forwarding network traffic from the private network to the “outside”, that is, the Internet. Security on the private network (LAN) is increased since most broadband routers are pre-configured to stop attempts to access the private network (LAN) from the public network/Internet.

Use **NAT traversal** when your network camera is located on an intranet (LAN) and you wish to make it available from the other (WAN) side of a NAT router. With NAT traversal properly configured, all HTTP traffic to an external HTTP port in the NAT router is forwarded to the camera.

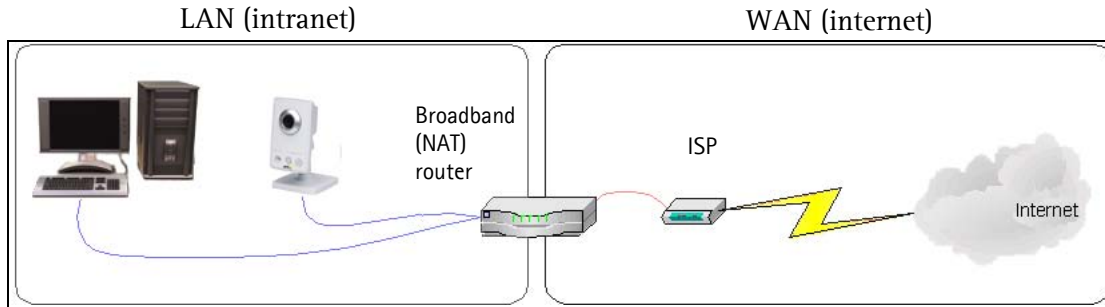

Notes:

- For NAT traversal to work, this must be supported by the broadband router.
- The broadband router has many different names: "NAT router", "Network router", "Internet Gateway", "Broadband sharing device" or "Home firewall" but the essential purpose of the device is the same.

Enable/Disable - when enabled, the network camera attempts to configure port mapping in a NAT router on your network, using UPnP™. Note that UPnP™ must be enabled in the camera (see **System Options > Network > UPnP**).

Use manually selected NAT router - select this option to manually select a NAT router and enter the IP address for the router in the field provided.

If a router is not manually specified, the network camera automatically searches for NAT routers on your network. If more than one router is found, the default router is selected.

Alternative HTTP port - select this option to manually define an external HTTP port. Enter the port number in the field provided. If no port is entered here a port number is automatically selected when NAT traversal is enabled.

Notes:

- An alternative HTTP port can be used/be active even if NAT traversal is disabled. This is useful if your NAT router does not support UPnP and you need to manually configure port forwarding in the NAT router.
- If you attempt to manually enter a port that is already in use, another available port is automatically selected.
- When the port is selected automatically it is displayed in this field. To change this enter a new port number and click Save.

FTP - The FTP server running in the network cameras enables the upload of new firmware, and user applications. Check the box to enable the service.

RTSP - The RTSP protocol allows a connecting client to start an H.264/MPEG-4 stream. Check the box to enable the server and enter the RTSP port number to use. The default setting is 554. Note that H.264/MPEG-4 video streams will not be available if this service is not enabled.

Wireless (AXIS M1011-W/AXIS M1031-W only)

Wireless settings in the AXIS M1011-W/AXIS M1031-W must be the same as the access point or ad-hoc device. When changing the settings, they should always be made first in the camera and then in the wireless access point. This ensures that the camera is always accessible when making changes.

Status of Wireless Networks

This list is the result of a network scan. Access points with a disabled SSID Broadcast will not appear unless the camera is linked to it. The network the AXIS M1011-W/AXIS M1031-W is currently linked to is shown in blue. A network using unsupported security is shown in grey. The following information is provided:

- **SSID** – The name of a wireless network (or ad-hoc device). If the same name occurs several times this means that several access points for that network were found. The camera cannot be configured to only associate with one particular access point.
- **Mode** – Shows if the network type is Master (access point or router) or Ad-Hoc (another client).
- **Security** – Shows which type of security the network uses. See below for the security types supported by the camera.
- **Channel** – Shows the wireless channel currently in use.
- **Signal strength** – Shows the signal strength.
- **Bit rate** – Shows the bit rate in Mbit/s. This can only be shown for the access point currently in use. Note that the bit rate shown is the current rate, and that this value may vary over time.

Wireless Settings

These settings control how the camera interacts with the wireless network. Apart from identifying the wireless network, it is also possible to enable wireless encryption.

SSID – This is the name of the wireless network the camera is configured for. The field accepts up to 32 alphanumeric characters. The name must be exactly the same as that used in the wireless access point or the connection will not be established.

Leaving this field blank means the camera will attempt to access the nearest open network.

Note:

SSID is sometimes written as ESSID.

Network type – Setting this to Master means the camera will attempt to access the specified access point or the nearest open access point if the SSID is left blank. The Ad-hoc option allows the camera to connect to other wireless devices (clients).

Note:

WEP is the only available encryption method for the Ad-hoc setting (see below).

Security – The AXIS M1011-W/AXIS M1031-W has three security options:

- WPA-/WPA2-PSK
- WPA-/WPA2-Enterprise
- WEP

WPA-/WPA2-Enterprise is more secure than WPA-/WPA2-PSK, which in turn is more secure than WEP. For detailed instructions on setting up Wireless security in your AXIS M1011-W/AXIS M1031-W, refer to the Installation Guide.

WPA-/WPA2-PSK (Wi-Fi Protected Access – Pre-Shared Key)

The AXIS M1011-W/AXIS M1031-W uses a pre-shared key (PSK) to initiate WPA security. The pre-shared key is entered on the access point and on each device on the wireless network. The key can be entered either as Manual hex, as 64 hexadecimal (0-9, A-F) characters, or as a Passphrase, using 8 to 63 ASCII characters. The access point keeps out unauthorized users by requiring the key to communicate.

WPA-/WPA2-Enterprise (Wi-Fi Protected Access – Enterprise)

WPA-/WPA2-Enterprise is a security method that provides strong data protection for multiple users and large networks. It uses the 802.1X authentication framework with TKIP or AES encryption. Network users trying to gain access are verified through an authentication server.

Certificates – The client and server authenticate each other using digital certificates provided by a Certificate Authority. To gain access to the protected network, the AXIS M1011-W/AXIS M1031-W presents its certificate to the network switch. If the certificate is approved, the switch allows access. You may need to contact your network administrator for information on certificates, user IDs and passwords.

For more information on certificates refer to the online help  .

WEP (Wired Equivalent Protection)

The original security standard used in wireless networks that provides a minimal level of security that can deter minor intrusions.

Note:

Configuring the AXIS M1011-W/AXIS M1031-W using an unsecured wireless connection is not recommended, since passphrases and keys saved will be sent in plain text. The fastest, most secure method to configure AXIS M1011-W/AXIS M1031-W is using a wired connection, since it disables the wireless connection and ensures greater secrecy while entering settings.

SOCKS

SOCKS is a networking proxy protocol. The Axis network camera can be configured to use a SOCKS server to reach networks on the other side of a firewall/proxy server. This functionality is useful if the network camera is located on a local network behind a firewall, and notifications, uploads, alarms, and such need to be sent to a destination outside the local network (such as the Internet). See the online help  for more information.

QoS (Quality of Service)

Quality of Service (QoS) guarantees a certain level of a specified resource to selected traffic on a network. Quality can be defined as a maintained level of bandwidth, low latency, and no packet losses. The main benefits of a QoS-aware network can be summarized as:

- The ability to prioritize traffic and thus allow critical flows to be served before flows with lesser priority.
- Greater reliability in the network, thanks to the control of the amount of bandwidth an application may use, and thus control over bandwidth races between applications.

The QoS in Axis network video products marks the data packets for various types of network traffic originating from the product. This makes it possible for network routers and switches to reserve a fixed amount of bandwidth for these types of traffic. The network cameras mark the following types of traffic:

- video
- audio
- event/alarm
- management network traffic

QoS Settings – For each type of network traffic supported by your Axis network video product, enter a DSCP (Differentiated Services Codepoint) value. This value is used to mark the traffic's IP header. When the marked traffic reaches a network router or switch, the DSCP value in the IP header tells the router or switch the type of treatment to apply to this type of traffic, for example, how much bandwidth to reserve for it. Note that DSCP values can be entered in decimal or hex form, but saved values are always shown in decimal.

For more information on Quality of Service, please see the Axis support web at www.axis.com/techsup

SMTP (email)

Enter the host names (or IP addresses) and port numbers for your primary and secondary mail servers in the fields provided, to enable the sending of notifications and image email messages from the camera to predefined addresses via SMTP.

If your mail server requires authentication, check the box for **Use authentication to log in to this server** and enter the necessary information. See the online help  for more information.

SNMP

The Simple Network Management Protocol (SNMP) allows remote management of network devices. Depending on the level of security required, select the version of SNMP to use. The three levels of security are:

- SNMP V1 – includes no security.
- SNMP V2c – uses very simple security. The community name can be specified as a password for read or read/write access to all supported SNMP objects. The community is the the group of network devices using SNMP.
- SNMP V3 – provides encryption and secure passwords. HTTPS must be enabled.

Traps for SNMP v1/v2/v3

Traps are used by the camera to send messages to a management system for important events or status changes. These settings are used with SNMP v1/v2. To activate trap reporting, enter the IP address of the management server, and choose the trap community to use when sending a trap message to the management system.

SNMP v3 is a more secure version providing encryption and secure passwords. To use SNMP v3, HTTPS must be activated. To use traps with SNMP v3 an SNMP v3 management application is needed.

See the online help [?](#) for more information.

UPnP™

The network camera includes support for UPnP™. This is enabled by default, and the network camera then is automatically detected by operating systems and clients that support this protocol.

RTP/H.264 & MPEG-4

These settings are the port range, IP address, port number (video and audio), and Time-To-Live value to use for the video stream(s) in multicast H.264/MPEG-4 format. Only certain IP addresses and port numbers should be used for multicast streams. For more information, please see the online help [?](#).

Bonjour

The network cameras include support for Bonjour. When enabled, the camera is automatically detected by operating systems and clients that support this.

Ports & Devices

I/O Ports

This page allows configuration of the input and output ports supported by this device.

PIR Sensor

PIR Sensor State – This setting shows the current state of the PIR Sensor.

Sensitivity Settings – Sensitivity Settings is used to adjust the sensitivity of the PIR Sensor from 0 - 100%. The default sensitivity is 75%.

By increasing the sensitivity, the range of the PIR Sensor is also increased. The PIR Sensor can be configured to detect movement in the dark up to a maximum range of 6 meters. Move the **Sensitivity** slider to adjust the PIR Sensor's sensitivity and range.

LED Settings

The Status indicator LED on the front of the camera can be set to flash at a configurable interval (or to not light up at all) when the unit is accessed. For a listing of all LED behavior, see page 7, or the online help [?](#).

Notes:

- The illumination LED is not intended for constant operation, and has an estimated life span of 30 000 hours.
- The LED cannot be replaced.
- The LED should only be used for short periods when viewing video or when motion is detected.

Maintenance

- **Restart** - the camera is restarted without changing any settings.
- **Restore** - the unit is restarted and most current settings are reset to factory default values. The settings that do not reset are:
 - the boot protocol (DHCP or static)
 - the static IP address
 - the default router
 - the subnet mask
 - the system time
- **Default** - the default button should be used with caution. Pressing this returns the camera's settings to the factory default values (including the IP address).

Upgrade Server – See *Upgrading the Firmware*, on page 44.

Support

Support Overview

The **Support Overview** page provides valuable information on troubleshooting and contact information, should you require technical assistance.

System Overview

System Overview provides an overview of the camera's status and settings. Information that can be found here includes the camera's firmware version, IP address, security, event and image settings and recent log items. Many of the captions are also links to the proper Setup page to conveniently make adjustments in the camera's settings.

Logs & Reports

When contacting Axis support, please be sure to provide a valid Server Report with your query. The Access Log is automatically included in the server report.

Information

The **Server Report** and **Parameter List** help when troubleshooting a problem or when contacting the Axis support web.

- **System Log** - Provides information about system events.
- **Access Log** - By default, the Access Log lists all failed attempts to access the camera but can be configured to list all connections to the camera, whether successful or not. Go to **Support > Logs & Reports > Configuration** and select the desired level of information from the list. See *Configuration*, on page 42 for more information.
The Access Log is useful for various purposes such as tracking all access to the camera, simple web attraction tracking, system analysis and troubleshooting.

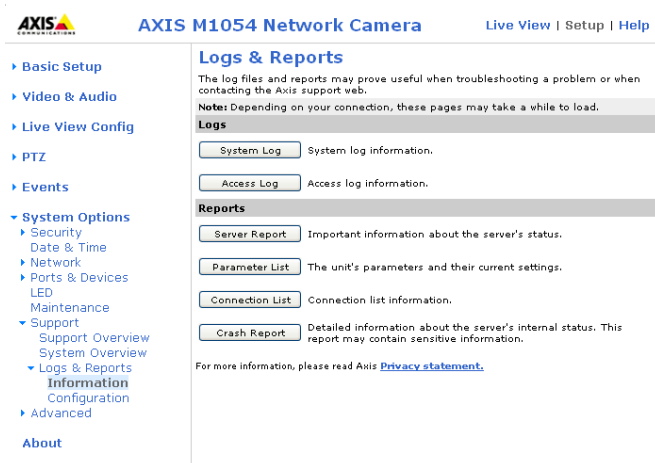

- **Server Report** – Provides information about the server status and should always be included when requesting support.
- **Parameter List** – Shows the unit's parameters and their current settings.
- **Connection List** – Lists all clients currently accessing video and audio. It is also used for system analysis and troubleshooting.

Configuration

From the drop-down lists, select the level of information to be added to the **System Log** and **Access Log** files and the permitted size of the log files. The default information level for the Access Log is set to Critical & Warnings, i.e. failed connections. However, in an error situation and when requesting support, set it to the highest information level – Critical & Warnings & Info.

For the Log Level for Email, select from the drop-down list the level of information to send as email and enter the destination email address.

Advanced

Scripting – Scripting is an advanced function that enables you to customize and use scripts. This function is a very powerful tool.

Caution!

Improper use may cause unexpected behavior or even cause loss of contact with the unit. If a script does cause problems, reset the unit to its factory default settings. A backup file may be of use to return the unit to its latest configuration.

Axis strongly recommends that you do not use this function unless you understand the consequences. Note that Axis support does not provide assistance for problems with customized scripts.

For more information, please visit the Developer pages at www.axis.com/developer

File Upload – Files can be uploaded (e.g. web pages and images) to be used as custom settings. Set user level access to control which files can be viewed by different users.

Plain Config – This function is for the advanced user with experience of Axis network camera configuration. All parameters can be set and modified from this page. Help is available from the standard help pages.

About

Here you can find basic information about your network camera. You can also view third party software licenses.

Resetting to the Factory Default Settings

To reset the camera to the original factory default settings, go to the **System Options > Maintenance** web page (as described in *Maintenance*, on page 41) or use the **Control** button (see page 6) as described below:

Using the Control Button

To reset the camera to the factory default settings using the Control Button:

1. Disconnect the power cable, or if using PoE, disconnect the network cable.
2. Press and hold the Control button while reconnecting power.
3. Keep the Control button pressed until the **Status Indicator** color changes to amber (this may take up to 15 seconds).
4. Release the Control button.
5. When the Status Indicator changes to green (which may take up to 1 minute), the process is complete and the camera has been reset. The unit now has the default IP address 192.168.0.90

AXIS M10 Series – Resetting to the Factory Default Settings

Note:

For other methods of setting the IP address, please refer to the product's Installation Guide that accompanies the product, or download a copy from www.axis.com

Troubleshooting

Checking the Firmware

Firmware is software that determines the functionality of the network cameras. One of your first actions when troubleshooting a problem should be to check the current firmware version. The latest version may contain a correction that fixes your particular problem. The current firmware version in your camera is displayed on the page **Setup > Basic Setup** or under **About**.

Upgrading the Firmware

When upgrading the camera with the latest firmware from the Axis Web site, the camera receives the latest functionality. Always read the upgrade instructions and release notes available with each new release, before updating the firmware.

Note:

Preconfigured and customized settings are saved when the firmware is upgraded (providing the features are available in the new firmware) although this is not guaranteed by Axis Communications. Always read the instructions and release notes available with each new release, before upgrading the firmware.

1. Save the firmware file to your computer. The latest version of the firmware is available free of charge from the Axis website at www.axis.com/techsup
2. Go to **Setup > System Options > Maintenance** in the camera's web pages.
3. Under **Upgrade Server** browse to the desired firmware file on your computer. Click **Upgrade**.

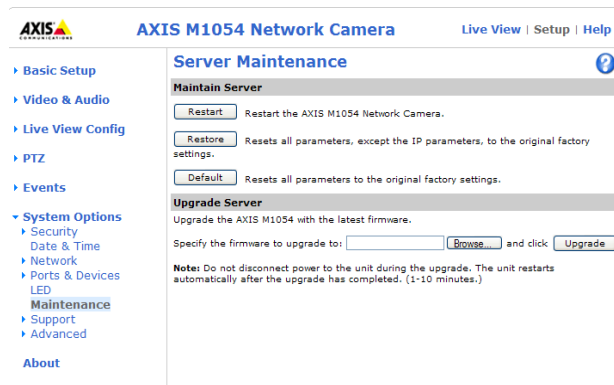

Notes:

- After starting the upgrade process, always wait at least 5-10 minutes before restarting the camera, even if you suspect the upgrade has failed.
- Your dealer reserves the right to charge for any repair attributable to faulty upgrading by the user.
- The AXIS Camera Management software tool can be used for multiple upgrades. Please see the Axis website at www.axis.com for more information.

Emergency Recovery Procedure

If power or the network connection to the camera is lost during the upgrade, the process fails and the unit becomes unresponsive. A flashing red Status LED indicates a failed upgrade. To recover the unit, follow the steps below. The serial number is found on the label attached to the bottom of the camera.

1. **UNIX/Linux** - From the command line, type the following:

```
arp -s <IP address of camera> <serial number> temp
ping -s 408 <IP address of camera>
```

Windows - From a command/DOS prompt, type the following:

```
arp -s <IP address of camera> <serial number>
ping -l 408 -t <IP address of camera>
```
2. If the unit does not reply within a few seconds, restart it and wait for a reply. Press CTRL+C to stop Ping.
3. Open a browser and type in the camera's IP address. In the page that appears, use the **Browse** button to select the upgrade file to use, for example, `axism1031.bin`. Then click the **Load** button to restart the upgrade process.
4. After the upgrade is complete (1-10 minutes), the unit automatically restarts and shows a steady green on the Power and Status LEDs and flashing green or amber on the Network LED.
5. Reinstall the camera, referring to the installation guide.

If the emergency recovery procedure does not get the camera up and running again, please contact Axis support at www.axis.com/techsup/

Axis Support

If you contact Axis support, please help us to help you solve your problems by providing the server report, the log file and a detailed description of the problem.

Server Report - go to **Setup > System Options > Support > Support Overview**. The server report contains important information about the server and its software, as well as a list of the current parameters.

The **Log file** is available from **Setup > System Options > Support > Logs & Reports**. The Log file records events in the unit since the last system restart and can be a useful diagnostic tool when troubleshooting.

Symptoms, Possible Causes, and Remedial Action

Problems setting the IP address	
When using ARP/Ping	Try the installation again. The IP address must be set within two minutes after power has been applied to the camera. Ensure the Ping length is set to 408. See the Installation Guide.
The camera is located on a different subnet	If the IP address intended for the camera and the IP address of your computer are located on different subnets, you will not be able to set the IP address. Contact your network administrator to obtain an appropriate IP address.
The IP address is being used by another device	Disconnect the camera from the network. Run the Ping command. (In a Command/DOS window, type ping and the IP address of the unit). If you receive: Reply from <IP address>: bytes = 32; time = 10 ms..... - this means that the IP address may already be in use by another device on your network. You must obtain a new IP address and reinstall the unit. If you see: Request timed out - this means that the IP address is available for use with your camera. In this case, check all cabling and reinstall the unit.
Possible IP address conflict with another device on the same subnet	The static IP address in the camera is used before the DHCP server sets a dynamic address. This means that if the same default static IP address is also used by another device, there may be problems accessing the camera. To avoid this, set the static IP address to 0.0.0.0.
The camera cannot be accessed from a browser	
Problems with ONVIF	If ONVIF is not working as expected, it may be that for security reasons ONVIF was disabled when the camera was accessed over VAPIX. To enable ONVIF, reset the product to Factory default settings (see page 42).
The IP address has been changed by DHCP	If the camera and client are on the same network, run AXIS IP Utility to locate the camera. Identify the camera using its model or serial number. Alternatively: 1) Move the camera to an isolated network or to one with no DHCP or BOOTP server. Set the IP address again, using the AXIS IP Utility (see the Installation Guide) or the ARP/Ping commands. 2) Access the unit and disable DHCP in the TCP/IP settings. Return the unit to the main network. The unit now has a fixed IP address that will not change. 3) As an alternative to 2), if dynamic IP address via DHCP or BOOTP is required, select the required service and then configure IP address change notification from the network settings. Return the unit to the main network. The unit now has a dynamic IP address, but will notify you if the address changes.
Certificate error when using 802.1X	For the authentication to work properly it is important to synchronize the time in the AXIS M1031-W Network Camera with an NTP server.
Other networking problems	Test the network cable by connecting it to another network device, then Ping that device from your workstation. See instructions above.
Camera is accessible locally, but not externally	
Broadband router configuration	To configure your broadband router to allow incoming data traffic to the camera, enable the NAT-traversal feature which will attempt to automatically configure the router to allow access to the camera. This is enabled from Setup > System Options > Network > TCP/IP Advanced.
Firewall protection	Check the Internet firewall with your system administrator.
Default routers required	Check if you need to configure the default router settings.
Problems with the H.264/MPEG-4 format	
No H.264/MPEG-4 displayed in the client	Check that the correct network interface is selected in the AMC control panel applet (network tab). Check that the relevant H.264 connection methods are enabled in the AMC control panel applet (network tab). In the AMC control panel applet, select the H.264/MPEG-4 tab and click the button Set to default H.264/MPEG-4 decoder.
No multicast H.264/MPEG-4 displayed in the client	Check with your network administrator that the multicast addresses used by the camera are valid for your network. Check with your network administrator to see if there is a firewall preventing viewing.
Multicast H.264/MPEG-4 only accessible by local clients	Check if your router supports multicasting, or if the router settings between the client and the server need to be configured. The TTL (Time To Live) value may need to be increased.

Poor rendering of H.264/MPEG-4 images	Color depth set incorrectly on clients. Set to 16-bit or 32-bit color. If text overlays are blurred, or if there are other rendering problems, you may need to enable Advanced Video Rendering from the H.264/MPEG-4 tab in the AMC control panel applet. Ensure that your graphics card is using the latest device driver. The latest drivers can usually be downloaded from the manufacturer's web site.
Color saturation is different in H.264 and Motion JPEG	Modify the settings for your graphics adapter. Please see the adapter's documentation for more information.
Lower frame rate than expected	Reduce number of applications running on the client computer. Limit the number of simultaneous viewers. Check with the system administrator that there is enough bandwidth available. See also the online help. Check in the AMC control panel applet (H.264/MPEG-4 tab) that video processing is not set to Decode only I frames . Lower the image resolution.
Why do I not get 30 frames per second?	See the section <i>General performance considerations</i> , on page 53.
Image degeneration	Decrease the GOV length, see the online help for more information.
The Power indicator is not constantly lit	
Faulty power supply	Check that you are using an AXIS PS-H or AXIS PS-V power supply.
The Status and Network indicator LEDs are flashing red rapidly	
Hardware failure	Contact your Axis dealer.
The Status indicator LED is flashing red and the camera is inaccessible	
A firmware upgrade has been interrupted or the firmware has otherwise been damaged	See the <i>Emergency Recovery Procedure</i> above.
No images displayed on web page	
Problem with AMC. (<i>Internet Explorer only</i>)	To enable the updating of video images in Microsoft Internet Explorer, set your browser to allow ActiveX controls. Also, make sure that AXIS Media Control (AMC) component is installed on your workstation.
Installation of additional ActiveX component restricted or prohibited	Configure your camera to use a Java applet for updating the video images under Live View Config > Layout > Default Viewer for Internet Explorer. See the online help for more information.
Video/Image problems, general	
Image too dark or too light	Check the video image settings. See the online help on Video and Image Settings.
Missing images in uploads	This can occur when trying to use a larger image buffer than is actually available. Try lowering the frame rate or the upload period.
Slow image update	Configuring pre-buffers, motion detection, high-resolution images, or high frame rates, will affect the performance of the camera.
Poor performance	Poor performance may be caused by heavy network traffic, multiple users accessing the unit, low performance clients, use of features such as Motion Detection, Event handling.
Certificate error when using 802.1X	For authentication to work properly it is important to synchronize the time in the AXIS M10 Series network cameras with an NTP Server. See information on NTP server under Date and Time on page 34.
Poor quality snapshot images	
Screen incorrectly configured on your workstation	In Display Properties, configure your screen to show at least 65000 colors, that is, at least 16-bit. Using only 16 or 256 colors will produce dithering artifacts in the image.
Overlay/Privacy mask is not displayed	
Incorrect size or location of overlay or privacy mask.	The overlay or privacy mask may have been positioned incorrectly or may be too large. Refer to Overlay Image Requirements and Limitations in the online help for more information.
Browser freezes	
Mozilla/Firefox 1.4 (or later) can sometimes freeze on a slow computer	Lower the image resolution.
Problems uploading files	
Limited space	There is only limited space available for the upload of your own files. Try deleting existing files to free up space.
Motion Detection triggers unexpectedly	

Changes in luminance	Motion detection is based on changes in luminance in the image. This means that if there are sudden changes in the lighting, motion detection may be triggered mistakenly. Lower the sensitivity setting to avoid problems with luminance.
PIR Sensor sensitivity	
The PIR Sensor rarely triggers or not at all	The PIR Sensor will not work behind a window, the IR light is blocked by the window.
PIR sensitivity is either too high or too low	Use the Sensitivity slider to adjust the range and sensitivity of the PIR Sensor.
No audio	
Incorrect setup	Check the sound card in the PC. Ensure that the mute button is not pressed and the volume settings are correct.
No audio or very poor audio quality	Check that the correct Audio Input source is selected under Setup > Audio > Source . Select Microphone for the internal microphone or for a connected external microphone. Select Line in for a connected line in source.
Audio volume too low/high	
Volume settings incorrect	The volume of the microphone is either too high or too low. Change the volume for the microphone in the toolbar on the Live View page.
Poor audio quality	
CPU overloaded	Reduce the number of listeners and viewers and decrease the image resolution and compression.
Unsynchronized audio and video	It is recommended that the camera's time setting is synchronized with an NTP Server. This is enabled under System Options > Date & Time .
Distorted audio	Check that the correct Audio Input source is selected under Setup > Audio > Source . Select Microphone for the internal microphone or for a connected external microphone. Select Line for a connected line in source.

For further assistance, please contact your reseller or see the support pages on the Axis website at www.axis.com/techsup

Technical Specifications

Function/group	Item	Specification
Camera	Models	<ul style="list-style-type: none"> • AXIS M1011: Wired Interface • AXIS M1011-W: Wired and wireless interface • AXIS M1031-W: Wired and wireless interface, PIR sensor, illumination LED, audio • AXIS M1054: Power over Ethernet, PIR sensor, illumination LED, audio, I/O
	Image sensor	1/4" Progressive scan RGB CMOS
	Lens	<p>AXIS M1011, AXIS M1011-W, AXIS M1031-W</p> <ul style="list-style-type: none"> • 4.4 mm, F2.0, fixed iris, fixed focus • Horizontal angle of view: 47° <p>AXIS M1054</p> <ul style="list-style-type: none"> • 2,9 mm, F2.0, fixed iris, fixed focus • Horizontal angle of view: 84° • Vertical angle of view: 48°
	Light sensitivity	<p>AXIS M1011, AXIS M1011-W, AXIS M1031-W</p> <p>1 - 10000 lux, F2.0</p> <p>AXIS M1054</p> <p>1.2 - 100000 lux, F2.0</p> <p>AXIS M1031-W, AXIS M1054</p> <p>0 lux with illumination LED on</p>
	Shutter time	<p>AXIS M1011, AXIS M1011-W, AXIS M1031-W</p> <p>1/5000 s to 1/4 s</p> <p>AXIS M1054</p> <p>1/24500 s to 1/6</p>
Pan/Tilt/Zoom (AXIS M1054 only)	Digital PTZ, preset positions, guard tour	

AXIS M10 Series – Technical Specifications

Function/group	Item	Specification
Video	Video compression	H.264 (MPEG-4 Part 10/AVC, Baseline profile) Motion JPEG AXIS M1011, AXIS M1011-W, AXIS M1031-W MPEG-4 Part 2 (ISO/IEC 14496-2)
	Resolutions	AXIS M1011, AXIS M1011-W, AXIS M1031-W 640x480 to 160x120 AXIS M1054 1280x800 to 160x90
	Frame rate H.264	30 fps in all resolutions
	Frame rate Motion JPEG	30 fps in all resolutions
	Frame rate MPEG 4	AXIS M1011, AXIS M1011-W, AXIS M1031-W 30 fps in all resolutions
	Video streaming	Controllable frame rate and bandwidth AXIS M1011, AXIS M1011-W, AXIS M1031-W <ul style="list-style-type: none"> • Multiple, individually configurable streams in H.264, Motion JPEG and MPEG-4 Part 2 • VBR/CBR H.264 & MPEG-4 Part 2 AXIS M1054 <ul style="list-style-type: none"> • Multiple, individually configurable streams in H.264 • Motion JPEG • VBR/CBR H.264
Image settings	<ul style="list-style-type: none"> • Compression, color, brightness, sharpness, contrast, white balance, exposure control, exposure zones, backlight compensation, fine tuning of behavior at low light, rotation • Text and image overlay • Privacy mask AXIS M1054 Mirroring	
Audio (AXIS M1031-W and AXIS M1054)	Audio streaming	Two-way, half-duplex
	Audio compression	<ul style="list-style-type: none"> • AAC LC 8 kHz 32 kbit/s, 16 kHz 64 kbit/s • G.711 PCM 8 kHz 64 kbit/s • G.726 ADPCM 8 kHz 32 or 24 kbit/s
	Audio Input/Output	Built-in microphone and speaker
Network	Wireless Interface	AXIS M1011-W/AXIS M1031-W <ul style="list-style-type: none"> • IEEE 802.11g/b • Invisibly integrated antenna
	Security	Password protection, IP address filtering, HTTPS encryption, digest authentication, user access log AXIS M1011-W/AXIS M1031-W WEP 64/128 bit, WPA/WPA2-PSK
	Supported protocols	IPv4/v6, HTTP, HTTPS*, SSL/TLS*, QoS Layer 3 DiffServ, FTP, SMTP, Bonjour, UPnP, SNMPv1/v2c/v3(MIB-II), DNS, DynDNS, NTP, RTSP, RTP, TCP, UDP, IGMP, RTCP, ICMP, DHCP, ARP, SOCKS. *This product includes software developed by the Open SSL Project for use in the Open SSL Tool kit (www.openssl.org)

AXIS M10 Series – Technical Specifications

Function/group	Item	Specification
System Integration	Application Programming Interface	<ul style="list-style-type: none"> • Open API for software integration, including VAPIX® from Axis Communications*, AXIS Media Control SDK*, event trigger data in video stream, the ONVIF specification available at www.onvif.org • Quality of Service (QoS) layer 3, DiffServ Model • Embedded Linux operating system <p>*Available at www.axis.com</p> <p>AXIS M1054 Support for AXIS Video Hosting System (AVHS) with One-Click Camera connection</p>
	Intelligent Video	<p>Video motion detection, active tampering alarm AXIS M1031-W/AXIS M1054 Audio detection</p>
	Alarm triggers	<p>Intelligent video AXIS M1031-W Built-in PIR sensor AXIS M1054 Built-in PIR sensor, external input</p>
	Alarm events	<ul style="list-style-type: none"> • File upload via FTP, HTTP and email. • Notification via email, HTTP and TCP. <p>AXIS M1031-W Activation of illumination LED, audio clip playback AXIS M1054 Activation of illumination LED, audio clip playback, external output activation</p>
	Video buffer	<p>AXIS M1011, AXIS M1011-W, AXIS M1031-W 16 MB pre- and post alarm AXIS M1054 25 MB pre- and post alarm</p>
	Video access from web browser	<ul style="list-style-type: none"> • Camera live view • Video recording to file (ASF) • Customizable HTML pages • Windows Vista, XP, Server 2003 • DirectX 9c or higher <p>For other operating systems and browsers see www.axis.com/techsup</p>

AXIS M10 Series – Technical Specifications

Function/group	Item	Specification
General		
	Processors, memory	<p>AXIS M1011, AXIS M1011-W, AXIS M1031-W ARTPEC-B, 64 MB RAM, 32 MB Flash</p> <p>AXIS M1054 ARTPEC-3, 128 MB RAM, 128 MB Flash</p>
	Power	<p>4.9 – 5.1 V DC max. 6.5 W</p> <p>AXIS M1054 Power over Ethernet IEEE 802.3af Class 2</p>
	Connectors	<p>DC jack</p> <p>AXIS M1011, AXIS M1011-W, AXIS M1031-W RJ-45 10BASE-T/100BASE-TX Auto-MDIX</p> <p>AXIS M1054 RJ-45 10BASE-T/100BASE-TX PoE, DC jack, 1 alarm input and 1 output</p>
	PIR Sensor (AXIS M1031-W and AXIS M1054)	Passive infrared (PIR) motion sensor with configurable sensitivity. Max range: 6 m
	Illumination LED (AXIS M1031-W and AXIS M1054)	White illumination LED: 1 W
	Operating conditions	<p>Humidity 20 – 80% RH (non-condensing)</p> <p>AXIS M1011, AXIS M1011-W, AXIS M1031-W 0 – 50 °C (32 – 122 °F)</p> <p>AXIS M1054 0 – 40 °C (32 – 104 °F)</p>
	Approvals	<ul style="list-style-type: none"> • AXIS M1011: EN 55022 Class B, EN 55024, EN 61000-3-2, EN 61000-3-3, EN 60950-1, FCC Part 15 Subpart B Class B, VCCI Class B, ICES-003 Class B, C-tick • AXIS M1011-W and AXIS M1031-W: EN301489-1, EN301489-17, EN300328, EN 60950-1, FCC Part 15 Subpart B and C Class B, RSS-210, C-TICK, TELEC, KCC, SRRC • AXIS M1054 EN 55022 Class B, EN 61000-3-2, EN 61000-3-3, EN 55024, FCC Part 15 Subpart B Class B, ICES-003 Class B, VCCI Class B, C-tick AS/NZS CISPR 22, KCC Class B, EN 60950-1 • Power supply: EN 60950-1, cCSAus
	Dimensions (HxWxD)	28 x 59 x 95 mm (1.1"x2.3"x3.7")
	Weight	<ul style="list-style-type: none"> • AXIS M1011: 94 g (0.207 lb) • AXIS M1011-W: 94 g (0.207 lb) • AXIS M1031-W: 101 g (0.222 lb) • AXIS M1054: 156 g (0.344 lb)
	Included accessories	<p>Power supply, stand and clamp, Installation Guide, CD with installation tools, recording software and User's Manual, Windows decoder 1-user license</p> <p>AXIS M1054: Extension to stand</p>
	Optional accessories	Extension to stand
Video management software (not included)	AXIS Camera Station - Video management software for viewing and recording up to 50 cameras. See www.axis.com/products/video/software/ for more software applications via partners	

General performance considerations

When setting up your system, it is important to consider how various settings and situations will affect performance. Some factors affect the amount of bandwidth (the bit rate) required, others can affect the frame rate, and some affect both. If the load on the CPU reaches its maximum, this will also affect the frame rate.

The following factors are among the most important to consider:

- High image resolutions and/or lower compression levels result in larger images. Bandwidth affected.
- Access by large numbers of Motion JPEG and/or unicast H.264/MPEG-4 clients. Bandwidth affected.
- Simultaneous viewing of different streams (resolution, compression, etc.) by different clients. Frame rate and bandwidth affected.
- Accessing both Motion JPEG and H.264/MPEG-4 video streams simultaneously. Frame rate and bandwidth affected.
- Heavy usage of event settings affects the camera's CPU load. Frame rate affected.
- Enabled motion detection. Frame rate and bandwidth affected.
- Heavy network utilization due to poor infrastructure. Bandwidth affected.

Viewing on poorly performing client PC's lowers perceived performance. Frame rate affected.

Set the IP address with ARP/Ping

1. Acquire an IP address on the same network segment your computer is connected to.
2. Locate the serial number (S/N) on the network camera's label.
3. Open a command prompt on your computer and enter the following commands:

Windows syntax:	Windows example:
arp -s <IP Address> <Serial Number> ping -l 408 -t <IP Address>	arp -s 192.168.0.125 00-40-8c-18-10-00 ping -l 408 -t 192.168.0.125
UNIX/Linux/Mac syntax:	UNIX/Linux/Mac example:
arp -s <IP Address> <Serial Number> temp ping -s 408 <IP Address>	arp -s 192.168.0.125 00:40:8c:18:10:00 temp ping -s 408 192.168.0.125

4. Check that the network cable is connected to the camera and then start/restart the camera, by disconnecting and reconnecting power.
5. Close the command prompt when you see 'Reply from 192.168.0.125: ...' or similar.
6. In your browser, type in `http://<IP address>` in the Location/Address field and press Enter on your keyboard.

Notes:

- To open a command prompt in Windows: from the Start menu, select Run... and type cmd. Click OK.

To use the ARP command on a Mac OS X, use the Terminal utility in Application > Utilities.

Glossary of Terms

ActiveX – A standard that enables software components to interact with one another in a networked environment, regardless of the language(s) used to create them. web browsers may come into contact with ActiveX controls, ActiveX documents, and ActiveX scripts. ActiveX controls are often downloaded and installed automatically as required.

Advanced Audio Coding (AAC) – is a standardized, lossy compression and encoding scheme for digital audio, and is designed to be the successor of the MP3 format. AAC has the following advantages: better sound quality, smaller file sizes, multichannel and higher resolution audio, and it requires less processing power for decoding.

Angle – The field of view, relative to a standard lens in a 35mm still camera, expressed in degrees, e.g. 30°. For practical purposes, this is the area that a lens can cover, where the angle of view is determined by the focal length of the lens. A wide-angle lens has a short focal length and covers a wider angle of view than standard or telephoto lenses, which have longer focal lengths.

ARP (Address Resolution Protocol) – This protocol is used to associate an IP address to a hardware MAC address. A request is broadcast on the local network to discover the MAC address for an IP address.

ARTPEC (Axis Real Time Picture Encoder) – This chip is used for image compression.

ASIC (Application Specific Integrated Circuit) – A circuit designed for a specific application, as opposed to a general purpose circuit, such as a microprocessor.

Aspect ratio – A ratio of width to height in images. A common aspect ratio used for television screens and computer monitors is 4:3. High-definition television (HDTV) uses an aspect ratio of 16:9.

Audio feedback – This occurs when a sound loop exists between a microphone and a loudspeaker. The result is a loud high pitched squealing noise.

Autoiris (DC-Iris) – This special type of iris is electrically controlled by the camera, to automatically regulate the amount of light allowed to enter.

Bitmap – A bitmap is a data file representing a rectangular grid of pixels. It defines a display space and color for each pixel (or 'bit') in the display space. This type of image is known as a 'raster graphic.' GIFs and JPEGs are examples of image file types that contain bitmaps.

Because a bitmap uses this fixed raster method, it cannot easily be rescaled without losing definition. Conversely, a vector graphic image uses geometrical shapes to represent the image, and can thus be quickly rescaled.

Bit rate – The bit rate (in kbit/s or Mbit/s) is often referred to as speed, but actually defines the number of bits/time unit and not distance/time unit.

Bonjour – Also known as zero-configuration networking,

Bonjour enables devices to automatically discover each other on a network, without having to enter IP addresses or configure DNS servers. Bonjour is a trademark of Apple Computer, Inc.

Broadband – In network engineering terms, this describes transmission methods where two or more signals share the same carrier. In more popular terminology, broadband is taken to mean high-speed data transmission.

CCD (Charged Coupled Device) – This light-sensitive image device used in many digital cameras is a large integrated circuit that contains hundreds of thousands of photo-sites (pixels) that convert light energy into electronic signals. Its size is measured diagonally and can be 1/4", 1/3", 1/2" or 2/3".

CGI (Common Gateway Interface) – A specification for communication between a web server and other (CGI) programs. For example, a HTML page that contains a form might use a CGI program to process the form data once it is submitted.

CIF (Common Intermediate Format) – CIF refers to the analog video resolutions 352x288 pixels (PAL) and 352x240 pixels (NTSC). See also *Resolution*.

Client/Server – Client/server describes the relationship between two computer programs in which one program, the client, makes a service request from another program, the server, which fulfils the request. Typically, multiple client programs share the services of a common server program. A web browser is a client program that requests services (the sending of web pages or files) from a web server.

CMOS (Complementary Metal Oxide Semiconductor) – A CMOS is a widely used type of semiconductor that uses both negative and positive circuits. Since only one of the circuit types is on at any given time, CMOS chips require less power than chips using just one type of transistor. CMOS image sensors also allow processing circuits to be included on the same chip, an advantage not possible with CCD sensors, which are also much more expensive to produce.

Codec – In communications engineering, a codec is usually a coder/decoder. Codecs are used in integrated circuits or chips that convert e.g. analog video and audio signals into a digital format for transmission. The codec also converts received digital signals back into analog format. A codec uses analog-to-digital conversion and digital-to-analog conversion in the same chip.

Codec can also mean compression/decompression, in which case it is generally taken to mean an algorithm or computer program for reducing the size of large files and programs.

Compression – See *Image compression*.

DC-Iris (Autoiris) – This special type of iris is electrically controlled by the camera, to automatically regulate the amount of light allowed to enter.

DHCP (Dynamic Host Configuration Protocol) – DHCP is a protocol that lets network administrators automate and

centrally manage the assignment of Internet Protocol (IP) addresses to network devices in a network.

DHCP uses the concept of a 'lease' or amount of time that a given IP address will be valid for a computer. The lease time can vary, depending on how long a user is likely to require the network connection at a particular location.

DHCP also supports static addresses for e.g. computers running web servers, which need a permanent IP address.

DNS (Domain Name System) – DNS is used to locate and translate Internet domain names into IP (Internet Protocol) addresses. A domain name is a meaningful and easy-to-remember name for an Internet address. For example the domain name www.example.com is much easier to remember than 192.0.34.166. The translation tables for domain names are contained in Domain name servers.

Domain Server – Domains can also be used by organizations who wish to centralize the management of their (Windows) computers. Each user within a domain has an account that usually allows them to log in to and use any computer in the domain, although restrictions may also apply. The domain server is the server that authenticates the users on the network.

Duplex – See *Full-duplex*.

Ethernet – Ethernet is the most widely installed local area network technology. An Ethernet LAN typically uses special grades of twisted pair wires. The most commonly installed Ethernet systems are 10BASE-T and 100BASE-T10, which provide transmission speeds up to 10 Mbps and 100 Mbps respectively.

ETRAX (Ethernet Token Ring AXIS) – Axis' own microprocessor.

Factory default settings – These are the settings that originally applied for a device when it was first delivered from the factory. If it should become necessary to reset a device to its factory default settings, this will, for many devices, completely reset any settings that were changed by the user.

Firewall – A firewall works as a barrier between networks, e.g. between a Local Area Network and the Internet. The firewall ensures that only authorized users are allowed to access the one network from the other. A firewall can be software running on a computer, or it can be a standalone hardware device.

Focal length – Measured in millimeters, the focal length of a camera lens determines the width of the horizontal field of view, which in turn is measured in degrees.

FTP (File Transfer Protocol) – An application protocol that uses the TCP/IP protocols. It is used to exchange files between computers/devices on networks.

Frame – A frame is a complete video image. In the 2:1 interlaced scanning format of the RS-170 and CCIR formats, a frame is made up of two separate fields of 262.5 or 312.5 lines interlaced at 60 or 50 Hz to form a complete frame, which appears at 30 or 25 Hz. In video cameras with

a progressive scan, each frame is scanned line-by-line and not interlaced; most are also displayed at 30 and 25 Hz.

Frame rate – The frame rate used to describe the frequency at which a video stream is updated is measured in frames per second (fps). A higher frame rate is advantageous when there is movement in the video stream, as it maintains image quality throughout.

Full-duplex – Transmission of data in two directions simultaneously. In an audio system this would describe e.g. a telephone systems. Half-duplex also provides bi-directional communication, but only in one direction at a time, as in a walkie-talkie system. See also *Simplex*.

Gain – Gain is the amplification factor and the extent to which an analog amplifier boosts the strength of a signal. Amplification factors are usually expressed in terms of power. The decibel (dB) is the most common way of quantifying the gain of an amplifier.

Gateway – A gateway is a point in a network that acts as an entry point to another network. In a corporate network for example, a computer server acting as a gateway often also acts as a proxy server and a firewall server. A gateway is often associated with both a router, which knows where to direct a given packet of data that arrives at the gateway, and a switch, which furnishes the actual path in and out of the gateway for a given packet.

GIF (Graphics Interchange Format) – GIF is one of the most common file formats used for images in web pages. There are two versions of the format, 87a and 89a. Version 89a supports animations, i.e. a short sequence of images within a single GIF file. A GIF89a can also be specified for interlaced presentation.

GOV (Group Of VOPs) – A group of VOPs is the basic unit of an H.264/MPEG-4 video stream. The GOV contains different types and numbers of VOPs (I-VOPs, P-VOPs) as determined by the GOV length and GOV structure. See also *VOP*.

GOV length – The GOV length determines the number of images (VOPs) in the GOV structure. See also *GOV* and *VOP*.

GOV structure – The GOV structure describes the composition of an H.264/MPEG-4 video stream, as regards the type of images (I-VOPs or P-VOPs) included in the stream, and their internal order. See also *GOV* and *VOP*.

H.264 – A standard for video compression, also known as MPEG-4 Part 10.

Half-duplex – See *Full-duplex*.

HTML (Hypertext Markup Language) – HTML is the set of "markup" symbols or codes inserted in a file intended for display in web browser. The markup tells the browser how to display the page's words and images for the user.

HTTP (Hypertext Transfer Protocol) – HTTP is the set of rules for exchanging files (text, graphic images, sound, video, and other multimedia files) on the web. The HTTP protocol runs on top of the TCP/IP suite of protocols.

Hub – A (network) hub is used to connect multiple devices to the network. The hub transmits all data to all devices connected to it, whereas a switch will only transmit the data to the device it is specifically intended for.

IEEE 802.11 – A family of standards for wireless LANs. The 802.11 standard supports 1 or 2 Mbit/s transmission on the 2.4 GHz band. IEEE 802.11b specifies an 11 Mbit/s data rate on the 2.4 GHz band, while 802.11a allows up to 54 Mbit/s on the 5 GHz band.

Image compression – Image compression minimizes the file size (in bytes) of an image. Two of the most common compressed image formats are JPEG and GIF.

Interlacing – Interlaced video is video captured at 50 pictures (known as fields) per second, of which every 2 consecutive fields (at half height) are then combined into 1 frame. Interlacing was developed many years ago for the analog TV world and is still used widely today. It provides good results when viewing motion in standard TV pictures, although there is always some degree of distortion in the image.

To view interlaced video on e.g. a computer monitor, the video must first be de-interlaced, to produce progressive video, which consists of complete images, one after the other, at 25 frames per second. See also *Progressive scan*.

IP (Internet Protocol) – The Internet Protocol is a method transmitting data over a network. Data to be sent is divided into individual and completely independent "packets." Each computer (or host) on the Internet has at least one address that uniquely identifies it from all others, and each data packet contains both the sender's address and the receiver's address.

The Internet Protocol ensures that the data packets all arrive at the intended address. As IP is a connectionless protocol, which means that there is no established connection between the communication end-points, packets can be sent via different routes and do not need to arrive at the destination in the correct order.

Once the data packets have arrived at the correct destination, another protocol - Transmission Control Protocol (TCP) - puts them in the right order. See also *TCP*.

IP Address – An IP address is simply an address on an IP network used by a computer/device connected to that network. IP addresses allow all the connected computers/devices to find each other and to pass data back and forth.

To avoid conflicts, each IP address on any given network must be unique. An IP address can be assigned as fixed, so that it does not change, or it can be assigned dynamically (and automatically) by DHCP.

An IP address consists of four groups (or quads) of decimal digits separated by periods, e.g. 130.5.5.25. Different parts of the address represent different things. Some part will represent the network number or address, and some other part will represent the local machine address.

See also *IP (Internet Protocol)*.

I-VOP – See *VOP*.

JPEG (Joint Photographic Experts Group) – Together with

the GIF file format, JPEG is an image file type commonly used on the web. A JPEG image is a bitmap, and usually has the file suffix '.jpg' or '.jpeg.' When creating a JPEG image, it is possible to configure the level of compression to use. As the lowest compression (i.e. the highest quality) results in the largest file, there is a trade-off between image quality and file size.

kbit/s (kilobits per second) – A measure of the bit rate, i.e. the rate at which bits are passing a given point. See also *Bit rate*.

LAN (Local Area Network) – A LAN is a group of computers and associated devices that typically share common resources within a limited geographical area.

LED – A light-emitting diode (LED) is a semiconductor device that emits visible light when an electric current passes through it. LEDs are widely used as indicator lights on electronic devices. Axis products commonly have LEDs for network, power and status.

Linux – Linux is an open source operating system within the UNIX family. Because of its robustness and availability, Linux has won popularity in the open source community and among commercial application developers.

MAC address (Media Access Control address) – A MAC address is a unique identifier associated with a piece of networking equipment, or more specifically, its interface with the network. For example, the network card in a computer has its own MAC address.

Manual iris – This is the opposite to an autoiris, i.e. the camera iris must be adjusted manually to regulate the amount of light allowed to reach the image sensor.

Mbit/s (Megabits per second) – A measure of the bit rate, i.e. the rate at which bits are passing a given point. Commonly used to give the 'speed' of a network. A LAN might run at 10 or 100 Mbit/s. See also *Bit rate*.

Monitor – A monitor is very similar to a standard television set, but lacks the electronics to pick up regular television signals.

Motion JPEG – Motion JPEG is a simple compression/decompression technique for networked video. Latency is low and image quality is guaranteed, regardless of movement or complexity of the image. Image quality is controlled by adjusting the compression level, which in turn provides control over the file size, and thereby the bit rate.

High-quality individual images from the Motion JPEG stream are easily extracted. See also *JPEG*.

Megapixel – See *Pixel*.

MPEG (Moving Picture Experts Group) – The Moving Picture Experts Group develops standards for digital video and audio compression. It operates under the auspices of the International Organization for Standardization (ISO). The MPEG standards are an evolving series, each designed for a different purpose.

MPEG-2 – MPEG-2 is the designation for a group of audio

and video coding standards, and is typically used to encode audio and video for broadcast signals, including digital satellite and Cable TV. MPEG-2, with some modifications, is also the coding format used by standard commercial DVD movies.

MPEG-4 – A video compression standard that makes good use of bandwidth, and which can provide DVD-quality video streams at less than 1 Mbit/s.

Multicast – Bandwidth-conserving technology that reduces bandwidth usage by simultaneously delivering a single stream of information to multiple network recipients.

Network connectivity – The physical (wired or wireless) and logical (protocol) connection of a computer network or an individual device to a network, such as the Internet or a LAN.

NTSC (National Television System Committee) – NTSC is the television and video standard in the United States. NTSC delivers 525 lines at 60 half-frames/second.

NWay – A network protocol that automatically negotiates the highest possible common transmission speed between two devices.

PAL (Phase Alternating Line) – PAL is the dominant television standard in Europe. PAL delivers 625 lines at 50 half-frames/second.

Ping – Ping is a basic network program used diagnostically to check the status of a network host or device. Ping can be used to see if a particular network address (IP address or host name) is occupied or not, or if the host at that address is responding normally. Ping can be run from e.g. the Windows Command prompt or the command line in UNIX.

PIR – A Passive InfraRed sensor (PIR Sensor) is an electronic device that measures infrared (IR) light radiating from objects in its field of view. They are generally used as motion detectors. Motion is detected when an infrared object such as person that has one temperature passes in front of another object that has a different temperature such as wall.

Pixel – A pixel is one of the many tiny dots that make up a digital image. The color and intensity of each pixel represents a tiny area of the complete image.

PoE (Power over Ethernet) – Power over Ethernet provides power to a network device via the same cable as used for the network connection. This is very useful for IP-Surveillance and remote monitoring applications in places where it may be too impractical or expensive to power the device from a power outlet.

PPP (Point-to-Point Protocol) – A protocol that uses a serial interface for communication between two network devices. For example, a PC connected by a phone line to a server.

PPTP (Point-to-Point Tunneling Protocol) – A protocol (set of communication rules) that allows corporations to extend their own corporate network through private “tunnels”

over the public Internet. In this way a corporation can effectively use a WAN (Wide Area Network) as a large single LAN (Local Area Network). This kind of interconnection is known as a virtual private network (VPN).

Pre/post alarm images – The images from immediately before and after an alarm. These images are stored in a buffer for later retrieval.

Progressive scan – Progressive scan, as opposed to interlaced video, scans the entire picture, line by line every sixteenth of a second. In other words, captured images are not split into separate fields as in interlaced scanning.

Computer monitors do not need interlace to show the picture on the screen, but instead show them progressively, on one line at a time in perfect order, i.e. 1, 2, 3, 4, 5, 6, 7 etc., so there is virtually no ‘flickering’ effect. In a surveillance application, this can be critical when viewing detail within a moving image, such as a person running. A high-quality monitor is required to get the best from progressive scan. See also *Interlacing*.

Protocol – A special set of rules governing how two entities will communicate. Protocols are found at many levels of communication, and there are hardware protocols and software protocols.

Proxy server – In an organization that uses the Internet, a proxy server acts as an intermediary between a workstation user and the Internet. This provides security, administrative control, and a caching service. Any proxy server associated with a gateway server, or part of a gateway server, effectively separates the organization’s network from the outside network and the local firewall. It is the firewall server that protects the network against outside intrusion.

A proxy server receives requests for Internet services (such as web page requests) from many users. If the proxy server is also a cache server, it looks in its local cache of previously downloaded web pages. If it finds the page, it is returned to the user without forwarding the request to the Internet. If the page is not in the cache, the proxy server, acting as a client on behalf of the user, uses one of its own IP addresses to request the page from another server over the Internet. When the requested page is returned, the proxy server forwards it to the user that originally requested it.

P-VOP – See *VOP*.

Resolution – Image resolution is a measure of how much detail a digital image can hold: the greater the resolution, the greater the level of detail. Resolution can be specified as the number of pixel-columns (width) by the number of pixel-rows (height), e.g. 320x240.

Alternatively, the total number of pixels (usually in megapixels) in the image can be used. In analog systems it is also common to use other format designations, such as CIF, QCIF, 4CIF, etc.

RTCP (Real-Time Control Protocol) – RTCP provides support for real-time conferencing of groups of any size within an intranet. This support includes source identification and support for gateways like audio and

video bridges as well as multicast-to-unicast translators. RTCP offers quality-of-service feedback from receivers to the multicast group as well as support for the synchronization of different media streams.

RTP (Real-Time Transport Protocol) – RTP is an Internet protocol for the transport of real-time data, e.g. audio and video. It can be used for media-on-demand as well as interactive services such as Internet telephony.

RTSP (Real Time Streaming Protocol) – RTSP is a control protocol, and a starting point for negotiating transports such as RTP, multicast and Unicast, and for negotiating codecs.

RTSP can be considered a ‘remote control’ for controlling the media stream delivered by a media server. RTSP servers typically use RTP as the protocol for the actual transport of audio/video data.

Router – A device that determines the next network point to which a packet should be forwarded on its way to its final destination. A router creates and/or maintains a special routing table that stores information on how best to reach certain destinations. A router is sometimes included as part of a network switch. See also *switch*.

Server – In general, a server is a computer program that provides services to other computer programs in the same or other computers. A computer running a server program is also frequently referred to as a server. In practice, the server may contain any number of server and client programs. A web server is the computer program that supplies the requested HTML pages or files to the client (browser).

Sharpness – This is the control of fine detail within a picture. This feature was originally introduced into color TV sets that used notch filter decoders. This filter took away all high frequency detail in the black and white region of the picture. The sharpness control attempted to put some of that detail back in the picture. Sharpness controls are mostly superfluous in today’s high-end TVs. The only logical requirement for it nowadays is on a VHS machine.

Simplex – In Simplex operation, a network cable or communications channel can only send information in one direction.

SMTP (Simple Mail Transfer Protocol) – SMTP is used for sending and receiving e-mail. However, as it is ‘simple,’ it is limited in its ability to queue messages at the receiving end, and is usually used with one of two other protocols, POP3 or IMAP. These other protocols allow the user to save messages in a server mailbox and download them periodically from the server.

SMTP authentication is an extension of SMTP, whereby the client is required to log into the mail server before or during the sending of email. It can be used to allow legitimate users to send email while denying the service to unauthorized users, such as spammers.

SNMP (Simple Network Management Protocol) – SNMP forms part of the Internet Protocol suite, as defined by the Internet Engineering Task Force. The protocol can support

monitoring of network-attached devices for any conditions that warrant administrative attention.

Sockets – Sockets are a method for communication between a client program and a server program over a network. A socket is defined as ‘the endpoint in a connection.’ Sockets are created and used with a set of programming requests or ‘function calls’ sometimes called the sockets application programming interface (API).

SSL/TLS (Secure Socket Layer/Transport Layer Security) These two protocols (SSL is succeeded by TLS) are cryptographic protocols that provide secure communication on a network. SSL is commonly used over HTTP to form HTTPS, as used e.g. on the Internet for electronic financial transactions. SSL uses public key certificates to verify the identity of the server.

Subnet/subnet mask – A subnet is an identifiably separate part of an organization’s network. Typically, a subnet may represent all the machines at one geographic location, in one building, or on the same local area network (LAN). Having an organization’s network divided into subnets allows it to be connected to the Internet with a single shared network address.

The subnet mask is the part of the IP address that tells a network router how to find the subnet that the data packet should be delivered to. Using a subnet mask saves the router having to handle the entire 32-bit IP address; it simply looks at the bits selected by the mask.

Switch – A switch is a network device that connects network segments together, and which selects a path for sending a unit of data to its next destination. In general, a switch is a simpler and faster mechanism than a router, which requires knowledge about the network and how to determine the route. Some switches include the router function. See also *Router*.

TCP (Transmission Control Protocol) – TCP is used along with the Internet Protocol (IP) to transmit data as packets between computers over the network. While IP takes care of the actual packet delivery, TCP keeps track of the individual packets that the communication (e.g. requested a web page file) is divided into, and, when all packets have arrived at their destination, it reassembles them to re-form the complete file.

TCP is a connection-oriented protocol, which means that a connection is established between the two end-points and is maintained until the data has been successfully exchanged between the communicating applications.

Telnet – Telnet is a simple method with which to access another network device, e.g. a computer. The HTTP protocol and the FTP protocols allow you to request specific files from remote computers, but do not allow you logon as a user of that computer. With Telnet, you log on as a regular user with whatever privileges you may have been granted for specific applications and data residing on that computer.

UDP (User Datagram Protocol) – UDP is a communications protocol that offers limited service for exchanging data in a network that uses the Internet Protocol (IP). UDP is an alternative to the Transmission Control Protocol (TCP). The

advantage of UDP is that it is not required to deliver all data and may drop network packets when there is e.g. network congestion. This is suitable for live video, as there is no point in re-transmitting old information that will not be displayed anyway.

Unicast – Communication between a single sender and a single receiver over a network. A new connection is established for each new user.

URL (Uniform Resource Locator) – An "address" on the network.

Varifocal lens – A varifocal lens provides a wide range of focal lengths, as opposed to a lens with a fixed focal length, which only provides one.

VPN (Virtual Private Network) – This creates a secure "tunnel" between the points within the VPN. Only devices with the correct "key" will be able to work within the VPN. The VPN network can be within a company LAN (Local Area Network), but different sites can also be connected over the Internet in a secure way. One common use for VPN is for connecting a remote computer to the corporate network, via e.g. a direct phone line or via the Internet.

VOP (Video Object Plane) – A VOP is an image frame in an H.264/MPEG-4 video stream. There are several types of VOP:

- An I-VOP is complete image frame.
- A P-VOP codes the differences between images, as long as it is more efficient to do so. Otherwise it codes the whole image, which may also be a completely new image.

WAN (Wide-Area-Network) – Similar to a LAN, but on a larger geographical scale.

W-LAN (Wireless LAN) – A wireless LAN is a wireless local area network that uses radio waves as its carrier: where the network connections for end-users are wireless. The main network structure usually uses cables.

Web server – A web server is a program, which allows web browsers to retrieve files from computers connected to the Internet. The web server listens for requests from web browsers and upon receiving a request for a file sends it back to the browser.

The primary function of a web server is to serve pages to other remote computers; consequently, it needs to be installed on a computer that is permanently connected to the Internet. It also controls access to the server whilst monitoring and logging server access statistics.

WEP (Wireless Equivalent Privacy) – A wireless security protocol, specified in the IEEE 802.11 standard, which is designed to provide a wireless local area network (WLAN) with a level of security and privacy comparable to that usually expected of a wired LAN. Security is at two different levels; 40-bit and 128-bit encryption. The higher the bit number, the more secure the encryption.

WPA-PSK (Wi-Fi Protected Access – Pre-Shared Key) – This wireless encryption method uses a pre-shared key (PSK) for key management. Keys can usually be entered as manual hex values, as hexadecimal characters, or as a

Passphrase. WPA-PSK provides a greater degree of security than WEP.

WPA Enterprise – Instead of a pre-shared key or passphrase, WPA Enterprise uses 802.1 x RADIUS servers and an Extensible Authentication Protocol (EAP) for authentication. The enhanced WPA2 uses Advanced Encryption Standard (AES) instead of Temporal Key Integrity Protocol (TKIP) to provide stronger encryption mechanism. This encryption method provides greater security, but is difficult to configure and is not recommended for home users.

Zoom lens – A zoom lens can be moved (zoomed) to enlarge the view of an object to show more detail.

Index

A

AAC 23
 Action Buttons 23
 Action Event 27
 Ad-hoc 38
 Administrator 16
 Alarm 30
 ARP/Ping 35
 Audio Clips 21
 Audio Feedback 20
 Audio Input 20
 Audio output 20
 Audio Settings 20
 AVHS 36
 AXIS Media Control (AMC) 9, 15, 20
 AXIS Media Control toolbar 12

B

Bit Rate 17
 Bonjour 9

C

Camera Settings 18
 Camera tampering 29
 Certificates 38
 Control Button 6, 42

D

Date & Time 34
 Default Viewer 23
 DNS Configuration 36
 DNS Server 36
 Domain Name 36

E

Emergency Recovery Procedure 44
 Enable ARP/Ping 35
 Event Servers (FTP, HTTP & TCP) 27
 Event Types (Triggered, Scheduled & Action) 27
 Events 27
 Exposure settings 19

F

Frame Rate 16
 FTP Server 27
 Full duplex 20

G

General controls 12
 Glossary 54
 GOV Settings 17

H

H.264 & MPEG-4 16, 17, 18, 21, 23
 Host Name 36
 HTTP Server 27
 HTTPS 11, 32, 36

I

I/O Ports 40
 IEEE 802.1X 33, 38
 IP Address Filtering 32

L

Light 6
 Live View 12
 Live View Config 22
 Logs & Reports 41

M

Microphone/Speaker 6
 Motion Detection 30
 Motion JPEG 15

N

NAT traversal 10, 36, 37
 Network Connector 6
 Network Settings 34
 NTP Server 34

O

Operator 16
 Overlay Image 19

P

PIR Sensor 6, 28, 30, 31, 40
 Port Status 31
 Ports & Devices 40
 Post-trigger Buffer 28
 Power Connector 6
 Pre-trigger Buffer 28
 Privacy mask 19
 PTZ 25

Q

QuickTime 23

R

Resetting to the Factory Default Settings 41, 42

S

Scheduled Event 27, 29
 Security 32, 38
 Server Time 34
 Simplex 20
 SNMP 40
 SSID 38
 Stream Profiles 18
 Support 41
 System Options 32

T

TCP Server 27
 TCP/IP Settings 34
 Technical Specifications 49
 Time Mode 34
 Triggered Event 27
 Troubleshooting 44

U

Upgrade Server 41
Upgrading the Firmware 44
UPnP 36, 40
Users 32

V

Video & Audio settings 16, 25
Video Streams 14, 16

W

WEP 39
Wireless (Access point) 38
Wireless Network (SSID, Mode, Security, Channel, Signal strength & Bit rate) 37
WPA-/WPA2-Enterprise 38
WPA-/WPA2-PSK 38